



Originally Issued: 09/09/2014

Revised: 09/26/2016

Valid Through: 9/30/2017

## EVALUATION SUBJECT: AEP SPAN AND ASC BUILDING PRODUCTS: SINGLE SKIN STEEL ROOF AND WALL PANELS WITH CONCEALED FASTENERS

### REPORT HOLDER:

ASC Profiles LLC  
2110 Enterprise Blvd.  
West Sacramento, CA 95691  
(800) 733-4955  
[www.ascprofiles.com](http://www.ascprofiles.com)

### ASC Profiles Divisions:

AEP Span [www.aepspan.com](http://www.aepspan.com)  
ASC Building Products [www.ascbp.com](http://www.ascbp.com)

CSI Division: 07 - Thermal and Moisture Protection  
CSI Section: 07 61 00 - Sheet Metal Roofing  
CSI Section: 07 64 00 - Sheet Metal Wall Cladding

## 1.0 SCOPE OF EVALUATION

### 1.1 Compliance to the Following Codes & Regulations:

- 2012 International Building Code® (IBC)
- 2012 International Residential Code® (IRC)
- 2009 International Building Code® (IBC)
- 2009 International Residential Code® (IRC)

### 1.2 Evaluated in Accordance With:

- IAPMO Uniform ES EC011-2013

### 1.3 Properties assessed:

- Structural
- Fire resistance
- Other environmental properties (water, air, hail, wind-blown debris) were not evaluated as part of this report

## 2.0 PRODUCT USE

The AEP Span and ASC Building Products Single Skin Steel Roof and Wall Panels with Concealed Fasteners are used as exterior roof and wall covering panels. Roof panels comply with requirements for metal roof panels in Chapter 15 of the IBC, and Section R905 of the IRC. Wall panels comply with requirements for steel exterior wall coverings in Chapter 14 of the IBC, and Section R703 of the IRC.

## 3.0 PRODUCT DESCRIPTION

**3.1 Panels:** The panels are available in the profiles as illustrated in the figures accompanying the tables in this report. All panels are provided with a painted finish. The panel profiles are available in various lengths and widths and

thickness gages as follows:

Products evaluated within this report:	Width(s) (inches):	Gage No.(s):
Design Span® hp	12, 16, 17, 18	22 ga., 24 ga.
Klip Rib®	16	22 ga., 24 ga., 26 ga.
Prestige Series®	12	18 ga., 20 ga., 22 ga., 24 ga.
Select Seam®	12, 16	22 ga., 24 ga.
Skyline Roofing®	12, 16	26 ga.
Skyline Roofing® hp	16	24 ga.
Span-lok hp	12, 16	22 ga., 24 ga.
SpanSeam	12, 16	22 ga., 24 ga.

Note: 1 inch = 25.4 mm

**3.2 Base Material:** All No. 18 and No. 20 gage panels are manufactured from steel sheet with G90 galvanized coatings conforming to ASTM A653 SS Grade 40.

All No. 22 and No. 24 gage panels are manufactured from steel sheet with AZ50 aluminum-zinc alloy coatings conforming to ASTM A792 SS Grade 50, or from steel sheet with G90 galvanized coatings conforming to ASTM A653 SS Grade 50.

All No. 26 gage Klip Rib® panels are manufactured from steel sheet with AZ50 aluminum-zinc alloy coatings conforming to ASTM A792 SS Grade 80.

All No. 26 gage Skyline Roofing® panels are manufactured from steel sheet AZ50 aluminum-zinc alloy coatings conforming to ASTM A792 SS minimum Grade 33.

**3.3 Clips:** All panels within this report shall be installed with a concealed fastening system (not visible from panel exterior). Panels shall be attached to supports with either fasteners, or with clips and fasteners. All clips are formed from steel with either AZ50 aluminum-zinc alloy or G90 galvanized coatings conforming to ASTM A792 or ASTM A653 SS minimum Grade 33 respectively. Clips shall be supplied by ASC Profiles LLC. Clip types are identified in the panel installation tables within this report.

**3.4 Fasteners:** The fastener size and type requirements are identified in the panel installation tables within this report. All fasteners shall be zinc-plated with an added corrosion-resistant coating, or of a 300 series stainless steel construction. Self-





tapping metal-to-metal fasteners shall comply with ASTM C1513. Fasteners installed into preservative- or fire-retardant-treated wood complying with the IBC shall be 300 series stainless steel, or designed specifically for use with treated wood.

**3.5 Substrates:** ASC Profiles roof and wall panels may be installed over numerous substrates including, but not limited to, the following:

- Cold formed steel in accordance with AISI S100
- Hot rolled steel in accordance with AISC 360
- Concrete in accordance with ACI 318
- Plywood and OSB in accordance with DOC PS-1 and DOC PS-2
- Dimensional lumber in accordance with ANSI/AWS National Design Specification (NDS)<sup>®</sup>

The panel installation tables within this report provide applicable substrate limitations.

## 4.0 DESIGN AND INSTALLATION

General design and installation shall be in accordance with the referenced codes in Section 1.0 of this report, this report, ASC Profile's product installation guides, and ASC Profile's *Concealed Fastener Steel Roof and Wall Panel Structural Design Guide*. Where conflicts occur, the more restrictive shall govern.

## 5.0 LIMITATIONS

The AEP Span and ASC Building Products panels, clips, and fasteners described in this report are in compliance with, or are acceptable alternatives to what is specified in those codes listed in Section 1.0 of this report subject to the following limitations:

**5.1** Metal panels used in roof applications shall be applied to a solid or closely fitted deck, except where the roof covering is specifically designed to be applied to spaced support members. The panel installation tables within this report provide applicable substrate limitations.

**5.2** Calculations demonstrating compliance with this report shall be submitted to the code official for approval. The calculations shall be prepared by a registered design professional where required by the statutes of the jurisdiction in which the project is to be constructed.

**5.3** The minimum allowable roof panel slopes shall conform to IBC Section 1507.4 or IRC Section R905.4; or as stated within this report.

**5.4** Roof panel flashing requirements, when applicable, shall

comply with IBC Section 1503.2 and 1503.3 or IRC Sections R903.2, R903.3, and R905.4.6. Underlayment shall be installed in accordance with IBC Section 1507.4.5 or IRC Section R905.4.3.2 where applicable wind conditions occur.

**5.5** Panels used on exterior walls shall be flashed in accordance with IBC Section 1405.4 and shall be over a water-resistant barrier complying and installed in accordance with IBC Section 1403.2 or IRC Section R703.1. Vapor retarders shall be installed, as applicable, in accordance with IBC Section 1405.3.

**5.6** For load combinations that include wind uplift, the nominal wind load shall be permitted to be multiplied by 0.67 provided the conditions in AISI S100, Appendix A Section D6.2.1a Conditions (a) through (g) are satisfied.

**5.6.1** Compliance with Conditions (a) and (d) through (g) shall be satisfied by conformance to the panel installation tables within this report. Compliance with Conditions (b) and (c) shall be the responsibility of the structural design professional. Conditions (b) and (c) are listed here:

Condition (b): The wind load shall be calculated using ASCE/SEI 7 for components and cladding, in accordance with Method 1 (Simplified Procedure) or Method 2 (Analytical Procedure).

Condition (c): The area of the roof being evaluated is in Zone 2 (edge zone) or Zone 3 (corner zone), as defined in ASCE/SEI 7, i.e., the 0.67 factor does not apply to the field of the roof (Zone 1).

**5.7** Design of panel penetrations and other panel discontinuities shall be the responsibility of the structural design professional in accordance with IBC Section 1604.4 or in accordance with the manufacturer's installation instructions, when approved by the building official.

## 5.8 Product Performance

**5.8.1 Fire Resistance:** Roof assemblies complying with the requirements of IBC Section 1505.2 Exception 2, or IRC Section R902.1 Exception 2 are considered Class A roof assemblies. For other conditions, roof assemblies shall be listed as Class A, B, or C in accordance with ASTM E108 or UL 790 by an approved testing agency or shall be considered as non-classified roofing. ASC Profiles shall be contacted for information on specific listed assemblies.

**5.8.2 Air and Water Infiltration:** Air and water infiltration resistance is outside the scope of this report. Weather protection shall comply with Sections 5.4 or 5.5 of this report.

**5.8.3 Hail Resistance:** Hail resistance is outside the scope of this report.



Originally Issued: 09/09/2014

Revised: 09/26/2016

Valid Through: 9/30/2017

**5.8.4 Wind-Blown Debris Resistance:** Wind-blown debris resistance is outside the scope of this report.

## 6.0 SUBSTANTIATING DATA

Data submitted in conformance with IAPMO-UES Evaluation Criteria EC011, adopted September 2013. Test results are from laboratories in compliance with ISO/IEC 17025.

## 7.0 IDENTIFICATION

A permanent label bearing the name and address of the manufacturer (ASC Profiles, ASC Building Products, or AEP Span), the model number, IAPMO-UES Mark of Conformity, and this evaluation report number (Evaluation Report #ER-309) identifies the products listed in this report.

A die-stamp label bearing the name and address of the manufacturer (ASC Profiles, ASC Building Products, or AEP Span), the model number, IAPMO-UES Mark of Conformity, and this evaluation report number (Evaluation Report #ER-309) identifies the products listed in this report.

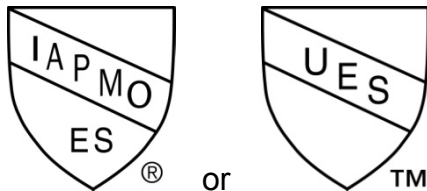

**IAPMO ER #309**

**Brian Gerber, P.E., S.E.**  
Vice President, Technical Operations  
Uniform Evaluation Service

**Richard Beck, PE, CBO, MCP**  
Director of Uniform Evaluation Service

**GP Russ Chaney**  
CEO, The IAPMO Group

For additional information about this evaluation report please visit [www.uniform-es.org](http://www.uniform-es.org) or email at [info@uniform-es.org](mailto:info@uniform-es.org)

# **Contents**

General Notes:.....	7
1- Span-lok hp & SpanSeam.....	9
Figure 1.1 - Span-lok hp Profile: .....	9
Figure 1.2 - SpanSeam Profile: .....	9
Table 1.1 - Span-lok hp & SpanSeam Profiles: .....	9
Table 1.2 - Attachment: .....	10
Table 1.3 - Section properties (12" Span-lok hp / SpanSeam):.....	11
Table 1.4 - Allowable reactions at supports (12" Span-lok hp / SpanSeam):.....	11
Table 1.5 - Positive (inward) uniform load design values (12" Span-lok hp / SpanSeam): .....	12
Table 1.6 - Clip/fastener attachment schedule (12", 22-24ga Span-lok hp / SpanSeam with Std. Clip):.....	13
Clip/fastener attachment schedule (12" Span-lok hp / SpanSeam w/low clip): .....	14
Table 1.7 - Section properties (16" Span-lok hp / SpanSeam):.....	14
Table 1.8 - Allowable reactions at supports (16" Span-lok hp / SpanSeam):.....	14
Table 1.9 - Positive (inward) uniform load design values (16" Span-lok hp / SpanSeam): .....	15
Table 1.10 - Clip/fastener attachment schedule (16", 22ga Span-lok hp / SpanSeam with Std. Clip): .....	16
Table 1.11 - Clip/fastener attachment schedules (16", 24ga Span-lok hp / SpanSeam with Std. Clip): .....	17
Table 1.12 - Clip/fastener attachment schedule (Span-lok hp / SpanSeam with low Clip): .....	18
2- Design Span hp .....	19
Figure 2.1 - Profile: .....	19
Table 2.1 - Profile:.....	19
Table 2.2 - Attachment: .....	20
Table 2.3 - Section properties (12" Design Span hp): .....	20
Table 2.4 - Allowable reactions at supports (12" Design Span hp): .....	21
Table 2.5 - Positive (inward) uniform load design values (12" Design Span hp): .....	21
Table 2.6 - Clip/fastener attachment schedules (12", 22 & 24ga Design Span hp): .....	22
Table 2.7 - Section properties (16" Design Span hp): .....	23
Table 2.8 - Allowable reactions at supports (16" Design Span hp): .....	23
Table 2.9 - Positive (inward) uniform load design values (16" Design Span hp): .....	24
Table 2.10 - Clip/fastener attachment schedule (16", 22ga Design Span hp): .....	25
Table 2.11 - Clip/fastener attachment schedule (16", 24ga Design Span hp): .....	26
Table 2.12 - Section properties (17" Design Span hp): .....	27
Table 2.13 - Allowable reactions at supports (17" Design Span hp): .....	27
Table 2.14 - Positive (inward) uniform load design values (17" Design Span hp): .....	28
Table 2.15 - Clip/fastener attachment schedules (17" & 18", 22ga Design Span hp): .....	29
Table 2.16 - Clip/fastener attachment schedules (17" & 18", 24ga Design Span hp): .....	30
Table 2.17 - Section properties (18" Design Span hp): .....	31
Table 2.18 - Allowable reactions at supports (18" Design Span hp): .....	31



Table 2.19 - Positive (inward) uniform load design values (18" Design Span hp): ..... 32

Clip/fastener attachment schedules (18" Design Span hp): ..... 32

3- Klip Rib ..... 33

Figure 3.1 - Profile: ..... 33

Table 3.1 - Profile:..... 33

Table 3.2 - Attachment: ..... 33

Table 3.3 - Section properties (Klip Rib):..... 34

Table 3.4 - Allowable reactions at supports (Klip Rib):..... 34

Table 3.5 - Positive (inward) uniform load design values (Klip Rib): ..... 35

Table 3.6 - Clip/fastener attachment schedule (22ga Klip Rib): ..... 36

Table 3.7 - Clip/fastener attachment schedule (24ga Klip Rib): ..... 37

Table 3.8 - Clip/fastener attachment schedule (26ga Klip Rib): ..... 38

4- Select Seam (Narrow Batten) ..... 39

Figure 4.1 - Profile: ..... 39

Table 4.1 - Profile:..... 39

Table 4.2 - Attachment: ..... 39

Table 4.3 - Section properties (12" Select Seam): ..... 40

Positive (inward) uniform load design values (12" Select Seam): ..... 40

Table 4.4 - Clip/fastener attachment schedule (12", 22ga Select Seam):..... 41

Table 4.5 - Clip/fastener attachment schedule (12", 24ga Select Seam):..... 42

Table 4.6 - Section properties (16" Select Seam): ..... 43

Positive (inward) uniform load design values (16" Select Seam): ..... 43

Table 4.7 - Clip/fastener attachment schedule (16", 22ga Select Seam):..... 44

Table 4.8 - Clip/fastener attachment schedule (16", 24ga Select Seam):..... 45

5- Prestige Series ..... 46

Figure 5.1 - Profile: ..... 46

Table 5.1 - Profile:..... 46

Table 5.2 - Attachment: ..... 46

Table 5.3 - Section properties (Full 12" Prestige Series):..... 47

Table 5.4 - Allowable reactions at supports (Full 12" Prestige Series):..... 47

Table 5.5 - Positive (inward) uniform load design values (Full 12" reveal Prestige Series): ..... 48

Table 5.6 - Clip/fastener attachment schedule (20-22ga Prestige Series with 0" or 1" reveal, DIRECT FASTENED):..... 49

Table 5.7 - Clip/fastener attachment schedule (24ga Prestige Series with 0" or 1" reveal, DIRECT FASTENED):..... 50

Table 5.8 - Clip/fastener attachment schedule (20-22ga Prestige Series with 0" or 1" reveal – CLIP ATTACHED): ..... 51



Table 5.9 - Clip/fastener attachment schedule (24ga Prestige Series with 0" or 1" reveal – CLIP ATTACHED): ..... 52

Table 5.10 - Section properties (1" reveal Prestige Series): ..... 53

Table 5.11 - Allowable reactions at supports (1" reveal Prestige Series):..... 53

Table 5.12 - Positive (inward) uniform load design values (1" reveal Prestige Series):..... 54

Clip/fastener attachment schedules (1" reveal Prestige Series): ..... 55

Table 5.13 - Section properties (2" reveal Prestige Series):..... 55

Table 5.14 - Allowable reactions at supports (2" reveal Prestige Series):..... 55

Table 5.15 - Positive (inward) uniform load design values (2" reveal Prestige Series):..... 56

Table 5.16 - Clip/fastener attachment schedule (20-22ga Prestige Series with 2" reveal, DIRECT FASTENED):..... 57

Table 5.17 - Clip/fastener attachment schedule (24ga Prestige Series with 2" reveal, DIRECT FASTENED):..... 58

Table 5.18 - Clip/fastener attachment schedule (20-22ga Prestige Series with 2" reveal, CLIP ATTACHED ): ..... 59

Table 5.19 - Clip/fastener attachment schedule (24ga Prestige Series with 2" reveal, CLIP ATTACHED): ..... 60

Table 5.20 - Section properties (6" reveal Prestige Series):..... 61

Table 5.21 - Allowable reactions at supports (6" reveal Prestige Series):..... 61

Table 5.22 - Positive (inward) uniform load design values (6" reveal Prestige Series):..... 62

Table 5.23 - Clip/fastener attachment schedule (20-22ga Prestige Series with 6" reveal) ..... 63

6- Skyline Roofing® & Skyline Roofing® hp ..... 64

Figure 6.1 - Profile: ..... 64

Table 6.1 – Profile:..... 64

Table 6.2 - Attachment: ..... 64

Table 6.3 - Section properties (12" Skyline Roofing®): ..... 65

Table 6.4 - Fastener attachment schedule (12", 26ga Skyline Roofing®): ..... 65

Table 6.5 - Section properties (16" Skyline Roofing® & Skyline Roofing® hp):..... 66

Table 6.6 - Fastener attachment schedule (16", 24ga Skyline Roofing® hp): ..... 66

Table 6.7 - Fastener attachment schedule (16", 26ga Skyline Roofing®): ..... 67





## General Notes:

The tables provided within this report will assist the user in determining which AEP Span or ASC Building Products' single skin, steel roof or wall panel with concealed fastener attachment is appropriate for resisting the specified project loads. For additional information and assistance in using this information, the *Concealed Fastener Steel Roof and Wall Panel Structural Design Guide* is available via the AEP Span or ASC Building Products' website, or the appropriate AEP Span or ASC Building Products' representative may be contacted for assistance.

The following information applies to all product tables within this report unless otherwise noted.

For SI: 1 inch = 25.4 mm; 1 foot = 305 mm; 1 lbf = 4.448 N; 1 psi = 6.895 MPa

### 1. Panel and clip summary charts:

Product information is provided in these charts to assist the user in specifying the correct panel and attachment method.

- Bearing plates referenced in clip tables are for installing clips over rigid insulation, or similar, where a larger clip bearing surface is required.
- Fastener load adjustment equations are provided to assist the user in understanding what adjustments need to be made to the fastener loads due to the eccentricity of the fasteners relative to the panel seam (load path).

### 2. Panel section properties:

Panel section properties provided within this report have been calculated in accordance with AISI S100.

### 3. Inward (positive/ gravity) allowable loads:

For uniform loading conditions, the appropriate support spacing is identified by referring to the inward load tables included in this report. For conditions not defined by these tables, support spacing shall be derived from standard engineering mechanics set forth in AISI S100 using the panel's section properties provided within this report.

- Information provided in these tables applies to uniform loads only.
- Table values denoted by '-' indicate that capacities are limited by panel strength, not deflection.
- The upper values,  $W/\Omega$  (ASD) and  $\phi W$  (LRFD), are based on allowable panel strength and have been evaluated for bending, shear, combined bending and shear, web crippling (reactions at supports), and combined bending and web crippling.
- The L/60 and L/180 values are based on allowable service load deflections.
- Tables are not presented for Select Seam and Skyline Roofing as these products require installation over solid or closely fitted deck where inward loads are limited by the capacity of the underlying substrate.

### 4. Reactions at supports:

Panel reactions at supports are governed by the capacity of the panel ribs on the supporting member. These capacities are based on web crippling testing in accordance with AISI S909. The end and interior reactions listed in the tables are for a uniformly distributed out-of-plane load applied to the panels. The capacities provided are for a 1.5 inch (38 mm) minimum support bearing width. Both ASD and LRFD capacities are listed.

### 5. Outward (negative/uplift) allowable loads:

Outward allowable panel/clip capacities were determined in accordance with IAPMO Uniform ES EC011 and the referenced AISI S100 and ASTM E1592 standards. These loads are based on a specific fastener and substrate combination. Project specific fastener-to-substrate capacities shall be evaluated by the structural design professional to determine if this report's published allowable outward loads need to be reduced accordingly. Increase in fastener loading due to the eccentricity of the fasteners relative to the panel seam shall also be taken into account. Fastener load adjustments are provided within the clip summary charts to assist with those calculations.

### 6. Clip/fastener attachment schedules:



Common panel attachment combinations and associated allowable outward wind load capacities are provided within this report. Using the project's defined wind loads, the appropriate Clip/Fastener Attachment Schedule shall be reviewed to determine the panel attachment that meets or exceeds these wind loads. Not all possible fastener and substrate combinations are listed within these attachment schedules. Alternative combinations are acceptable (i.e. attaching a panel assembly with fasteners into a concrete substrate). The structural design professional may rationally design other fastener and substrate combinations based on engineering mechanics and the maximum allowable panel/clip capacities stated within this report.

- Although nominal fastener sizes are provided in the tables, the appropriate fastener thread and point type shall still be properly specified for the selected substrate.
- Allowable clip/support connection strengths shall be reduced due to eccentricity of the fasteners relative to the panel seam using equations of mechanics. The panel clip summary charts provide the fastener load adjustment factors to be used.
- The following fastener pull out capacities were used in attachment schedules:

Cold Formed Steel, 55 ksi min.					
Screw / Diameter D (in)			#10 (0.190")	#12 (0.216")	1/4" (0.250")
Ga (nom.)	BMT	Pull Out Capacities (lbs)			
12	0.1050"	$P_a$	396	450	521
		$P_f$	594	675	781
14	0.0700"	$P_a$	264	300	347
		$P_f$	396	450	521
16	0.0590"	$P_a$	222	253	293
		$P_f$	333	379	439
18	0.0470"	$P_a$	177	201	233
		$P_f$	266	302	350

Cold Formed Steel, 33 ksi min.					
Screw / Diameter D (in)			#10 (0.190")	#12 (0.216")	1/4" (0.250")
Ga (nom.)	BMT	Pull Out Capacities (lbs)			
16	0.0598"	$P_a$	145	165	191
		$P_f$	217	247	286
18	0.0478"	$P_a$	116	132	152
		$P_f$	174	197	229
20	0.0359"	$P_a$	87	99	114
		$P_f$	130	148	172
22	0.0299"	$P_a$	72	82	95
		$P_f$	109	124	143

Plywood & OSB						
Screw / Diameter D (in)			#8 (0.164")	#10 (0.190")	#12 (0.216")	#14 (0.238")
Thickness	Pull Out Capacities (lb)					
15/32"	$P_a$	71	82	93	103	
	$P_f$	96	111	126	139	
19/32"	$P_a$	90	104	118	130	
	$P_f$	121	141	160	176	
23/32"	$P_a$	109	126	143	158	
	$P_f$	147	170	194	213	

Douglas Fir-Larch (DFL)						
Screw / Diameter D (in)			#8 (0.164")	#10 (0.190")	#12 (0.216")	#14 (0.238")
Fastener Penetration	Pull Out Capacities (lb)					
1" Min. (usable thread length)	$P_a$	180	208	236	261	
	$P_f$	242	281	319	352	

Fastener capacity table notes:

- $P_a$  = ASD Capacities (  $P/\Omega$  )       $P_f$  = LRFD Capacities (  $\phi P$  )
- Capacities in cold formed steel based on requirements in AISI S100-2007/S2-2010.
- Capacities in wood products based on 2012 NDS using a combined adjustment factor of 1.6 ( $C_D \times C_M \times C_t \times C_{eg} \times C_{tn}$ )
- The 1 inch (25.4 mm) minimum fastener penetration specified for the Douglas Fir-Larch values applies to the usable thread length and this minimum depth does not include the tapered portion of the fastener. For fastener penetrations above 1 inch (25.4 mm) the pullout values may be proportionally adjusted in accordance with the NDS.

For additional information and guidance regarding use of the data contained within this report, the ASC Profile's *Concealed Fastener Steel Roof and Wall Panel Structural Design Guide* is available.



## 1.0 Span-lok hp & SpanSeam

**Figure 1.1 - Span-lok hp Profile:**

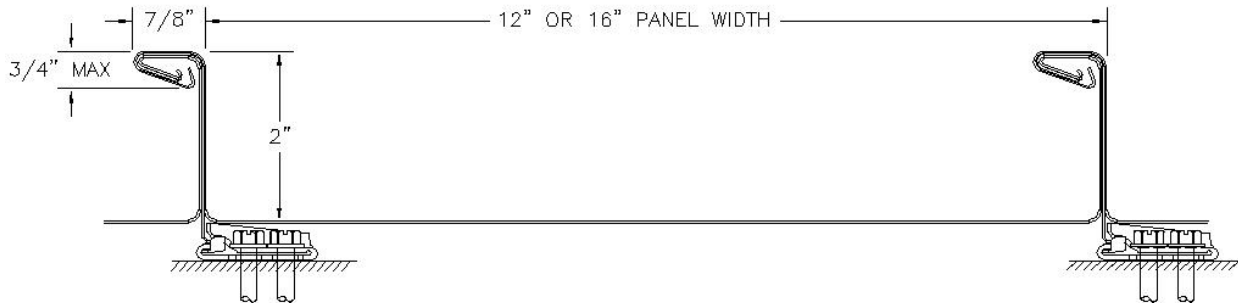

As-installed (mechanically seamed) view shown.

**Figure 1.2 - SpanSeam Profile:**

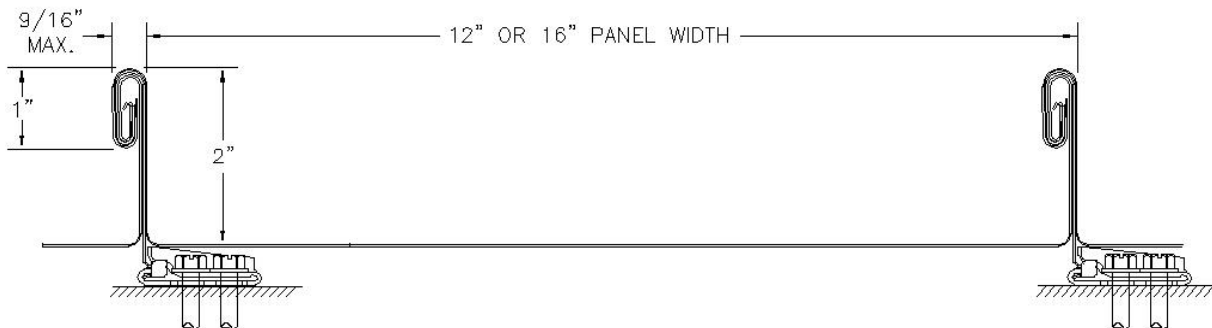

As-installed (mechanically seamed) view shown.

**Table 1.1 - Span-lok hp & SpanSeam Profiles:**

<b>Panel Use:</b>	Roof (primary use), wall, fascia
<b>Substrates:</b>	Over spaced supports or solid substrate
<b>Available Gages:</b>	No. 22, 24
<b>Minimum Slope:</b>	1/4:12 (2.083 percent)
<b>Load Combination Reduction Available (Ref. Section 5.6)</b>	Yes
<b>Mechanical Seaming:</b>	90° Seam (Span-lok hp) 180° Seam (SpanSeam). H2.083 percent and seam crimpers and powered seamers shall be from ASC Profiles Inc. or Developmental Industries Inc. <a href="http://www.diseamers.com">www.diseamers.com</a>
<b>Uninstalled Panel View (Span-lok hp):</b>	
<b>Uninstalled Panel View (SpanSeam):</b>	



Table 1.2 - Attachment

Clip Name:	Standard (Purlin) Clip	Low Profile Clip
Clip View:		
Clip Usage:	Over spaced framing or solid substrates	Over solid substrates
Part #:	#SL2CLP2.5 or #SL2CLP3	#SLCLPLOW2
Panel/ Substrate Gap:	½ inch or 1 inch	3/16 inch
Thermal Movement:	1 inch each direction	1 inch each direction
Fastener Limitations:	Nom. size: ¼ inch max. Head height: 3/8 inch max. Head dia.: ½ inch max.	Nom. size: ¼ inch max. Head height: 0.130 inch max. Head dia.: 5/8 inch max.
Recommended Fastener(s):	#12 or ¼ inch dia. hex washer head	#10 or #12 pancake head
Fastener Load Adjustments (due to eccentricity of fasteners relative to panel seam):	<u>2 fasteners: 2.00</u> $\Sigma M = 0$ $1.56P = .94R_1 + .44R_2$ <u>1 fastener: 1.66*</u> (* - use mtg. hole closest to panel seam) $\Sigma M = 0$ $1.56P = .94R_1$	<u>Per fastener: 1.625</u> $\Sigma M = 0$ $1.56P = .96R$
Associated Bearing Plate:	#SLBP	#BP3HOLE



**Table 1.3 - Section properties (12" Span-lok hp / SpanSeam panel):**

Gauge	Weight	Base Metal Thickness	Yield Strength	Tensile Strength	Gross Section Properties				
					Area	Moment of Inertia	Distance to N.A. from Bottom	Positive Section Modulus	Negative Section Modulus
	w	t	Fy	Fu	A <sub>g</sub>	I <sub>g</sub>	y <sub>b</sub>	S <sub>g+</sub>	S <sub>g-</sub>
	psf	in	ksi	ksi	in <sup>2</sup> /ft	in <sup>4</sup> /ft	in	in <sup>3</sup> /ft	in <sup>3</sup> /ft
24	1.49	0.0232	50	65	0.4373	0.2430	0.51	0.1636	0.4746
22	1.86	0.0294	50	65	0.5519	0.3040	0.51	0.2044	0.5953

Gauge	Effective Section Properties							Uniform Load Only	
	Area	Positive			Negative			I <sub>d</sub> = (2I <sub>e</sub> +I <sub>g</sub> )/3	
		Moment of Inertia	Distance to N.A. from Bottom	Section Modulus	Moment of Inertia	Distance to N.A. from Bottom	Section Modulus		
	A <sub>e</sub> /ft in <sup>2</sup>	I <sub>e+</sub> in <sup>4</sup> /ft	y <sub>b</sub> in	S <sub>e+</sub> in <sup>3</sup> /ft	I <sub>e-</sub> in <sup>4</sup> /ft	y <sub>b</sub> in	S <sub>e-</sub> in <sup>3</sup> /ft	I <sub>+</sub> in <sup>4</sup> /ft	I <sub>-</sub> in <sup>4</sup> /ft
24	0.1460	0.2220	0.47	0.1449	0.1022	1.16	0.0884	0.2290	0.1491
22	0.2078	0.2918	0.49	0.1937	0.1386	1.12	0.1242	0.2959	0.1937

**Table 1.4 - Allowable reactions at supports (12" Span-lok hp / SpanSeam panel):**

Gauge	Condition	Allowable (lbs/ft-width)	Factored (lbs/ft-width)
24	End	354	567
	Interior	530	848
22	End	534	855
	Interior	645	1031

Reaction capacities based on a minimum 1.5" support bearing width.



**Table 1.5 - Positive (inward) uniform load design values (12" Span-lok hp / SpanSeam panel):**

Gauge	Span	Condition	Positive (Inward) Uniform Load Capacity (lbs/ft <sup>2</sup> ) / Span (ft. - in.)						
			2' - 0"	2' - 6"	3' - 0"	3' - 6"	4' - 0"	4' - 6"	5' - 0"
24	Single Span	ASD, W/Ω	354	283	236	202	177	143	116
		LRFD, φW	567	454	378	324	283	227	184
		L/180	-	-	-	-	-	-	-
		L/60	-	-	-	-	-	-	-
	Double Span	ASD, W/Ω	212	169	141	121	106	85	70
		LRFD, φW	339	271	226	194	161	128	105
		L/180	-	-	-	-	-	-	-
		L/60	-	-	-	-	-	-	-
	Triple Span	ASD, W/Ω	241	193	160	138	120	106	86
LRFD, φW		385	308	257	220	193	159	130	
L/180		-	-	-	-	-	-	-	
L/60		-	-	-	-	-	-	-	
22	Single Span	ASD, W/Ω	534	427	356	305	242	191	155
		LRFD, φW	855	684	570	489	383	303	245
		L/180	-	-	-	-	-	-	-
		L/60	-	-	-	-	-	-	-
	Double Span	ASD, W/Ω	258	206	172	147	129	115	97
		LRFD, φW	412	330	275	236	206	181	146
		L/180	-	-	-	-	-	-	-
		L/60	-	-	-	-	-	-	-
	Triple Span	ASD, W/Ω	293	234	195	167	147	130	117
LRFD, φW		469	375	312	268	234	208	183	
L/180		-	-	-	-	-	-	-	
L/60		-	-	-	-	-	-	-	

Table values denoted by "-" indicate that capacities are limited by panel strength not deflection.



**Table 1.6 - Clip/fastener attachment schedule  
(12", No. 22 and 24 gage Span-lok hp / SpanSeam with Standard Clip)**

Substrate		Fastener		Attachment Spacing, (ft-in)																							
		# per clip	Size	1' - 0"	1' - 6"	2' - 0"	2' - 6"	3' - 0"	3' - 6"	4' - 0"	4' - 6"	5' - 0"	Panel / Clip Negative (Outward) Uniform Load Capacity, (lbs/ft <sup>2</sup> )														
				217	345	200	318	183	291	166	263	149	236	132	209	115	182	98	155	81	128						
				Panel System Negative (Outward) Uniform Load Capacity, (lbs/ft <sup>2</sup> )																							
ASD	LRFD	ASD	LRFD	ASD	LRFD	ASD	LRFD	ASD	LRFD	ASD	LRFD	ASD	LRFD	ASD	LRFD	ASD	LRFD	ASD	LRFD								
W/Ω	φW	W/Ω	φW	W/Ω	φW	W/Ω	φW	W/Ω	φW	W/Ω	φW	W/Ω	φW	W/Ω	φW	W/Ω	φW	W/Ω	φW								
Cold Formed Steel (Gr 55 min.)	12ga (.1050")	2	#10	217	345	200	318	183	291	158	238	132	198	113	170	99	149	88	132	79	119						
		2	#12	217	345	200	318	183	291	166	263	149	225	129	193	112	169	98	150	81	128						
		2	1/4"	217	345	200	318	183	291	166	263	149	236	132	209	115	182	98	155	81	128						
	14ga (.0700")	2	#10	217	345	176	264	132	198	106	158	88	132	75	113	66	99	59	88	53	79						
		2	#12	217	345	200	300	150	225	120	180	100	150	86	129	75	113	67	100	60	90						
		2	1/4"	217	345	200	318	174	261	139	208	116	174	99	149	87	130	77	116	69	104						
	16ga (.0590")	2	#10	217	333	148	222	111	167	89	133	74	111	64	95	56	83	49	74	44	67						
		2	#12	217	345	169	253	126	190	101	152	84	126	72	108	63	95	56	84	51	76						
		2	1/4"	217	345	195	293	146	220	117	176	98	146	84	125	73	110	65	98	59	88						
	18ga (.0470")	2	#10	177	266	118	177	89	133	71	106	59	89	51	76	44	67	39	59	35	53						
		2	#12	201	302	134	201	101	151	81	121	67	101	58	86	50	76	45	67	40	60						
		2	1/4"	217	345	155	233	117	175	93	140	78	117	67	100	58	88	52	78	47	70						
Cold Formed Steel (Gr 33 min.)	16ga (.0598")	2	#10	145	217	97	145	72	109	58	87	48	72	41	62	36	54	32	48	29	43						
		2	#12	165	247	110	165	82	124	66	99	55	82	47	71	41	62	37	55	33	49						
		2	1/4"	191	286	127	191	95	143	76	114	64	95	54	82	48	72	42	64	38	57						
	18ga (.0478")	2	#10	116	174	77	116	58	87	46	70	39	58	33	50	29	44	26	39	23	35						
		2	#12	132	197	88	131	66	99	53	79	44	66	38	56	33	49	29	44	26	39						
		2	1/4"	152	229	102	153	76	115	61	92	51	76	44	65	38	57	34	51	30	46						
	20ga (.0359")	2	#10	87	130	58	87	43	65	35	52	29	43	25	37	22	33	19	29	17	26						
		2	#12	99	148	66	99	49	74	40	59	33	49	28	42	25	37	22	33	20	30						
		2	1/4"	114	172	76	115	57	86	46	69	38	57	33	49	29	43	25	38	23	34						
	22ga (.0299")	2	#10	72	109	48	73	36	55	29	44	24	36	21	31	18	27	16	24	14	22						
		2	#12	82	124	55	83	41	62	33	50	27	41	24	35	21	31	18	28	16	25						
		2	1/4"	95	143	64	95	48	72	38	57	32	48	27	41	24	36	21	32	19	29						
Plywood & OSB	15/32"	2	#10	82	111	55	74	41	56	33	44	27	37	23	32	21	28	18	25	16	22						
		2	#12	93	126	62	84	47	63	37	50	31	42	27	36	23	32	21	28	19	25						
		2	#14	103	139	69	93	52	70	41	56	34	46	29	40	26	35	23	31	21	28						
	19/32"	2	#10	104	141	69	94	52	71	42	56	35	47	30	40	26	35	23	31	21	28						
		2	#12	118	160	79	107	59	80	47	64	39	53	34	46	30	40	26	36	24	32						
		2	#14	130	176	87	117	65	88	52	70	43	59	37	50	33	44	29	39	26	35						
	23/32"	2	#10	126	170	84	113	63	85	50	68	42	57	36	49	32	43	28	38	25	34						
		2	#12	143	194	96	129	72	97	57	78	48	65	41	55	36	49	32	43	29	39						
		2	#14	158	213	105	142	79	107	63	85	53	71	45	61	39	53	35	47	32	43						
Lumber (DFL)	1" min	2	#10	208	281	139	187	104	141	83	112	69	94	59	80	52	70	46	62	42	56						
		2	#12	217	319	158	213	118	160	95	128	79	106	68	91	59	80	53	71	47	64						
		2	#14	217	345	174	235	130	176	104	141	87	117	74	101	65	88	58	78	52	70						

**Specific Notes (Refer to the General Notes section for other applicable notes):**

1. Table accounts for increased loads on fasteners due to the eccentricity of the fasteners relative to the panel seam. The Span-lok hp & SpanSeam panel summary chart at the front of this section provides for development of these fastener load adjustments.
2. Number of clip fasteners can be reduced to (1) if project load requirements can still be met. The tabulated panel system capacities shall be reduced by 40% ( $fastener\ capacity \times Qty=1 \div 1.66$  is 40% of  $fastener\ capacity \times Qty=2 \div 2.0$ ). The fastener hole closest to the panel seam must be used. The Span-lok hp & SpanSeam panel summary chart at the front of this section provides for development of these fastener load adjustments.



**Clip/fastener attachment schedule (12" Span-lok hp / SpanSeam w/low clip):**  
**Table 1.12 applies**

**Table 1.7 - Section properties (16" Span-lok hp / SpanSeam):**

Gauge	Weight	Base Metal Thickness	Yield Strength	Tensile Strength	Gross Section Properties				
					Area	Moment of Inertia	Distance to N.A. from Bottom	Positive Section Modulus	Negative Section Modulus
	w psf	t in	F <sub>y</sub> ksi	F <sub>u</sub> ksi	A <sub>g</sub> in <sup>2</sup> /ft	I <sub>g</sub> in <sup>4</sup> /ft	y <sub>b</sub> in	S <sub>g+</sub> in <sup>3</sup> /ft	S <sub>g-</sub> in <sup>3</sup> /ft
24	1.36	0.0232	50	65	0.3976	0.1965	0.43	0.1250	0.4634
22	1.71	0.0294	50	65	0.5021	0.2460	0.42	0.1562	0.5806

Gauge	Effective Section Properties							Uniform Load Only	
	Area	Positive			Negative				
		Moment of Inertia	Distance to N.A. from Bottom	Section Modulus	Moment of Inertia	Distance to N.A. from Bottom	Section Modulus	$I_d = (2I_e + I_g)/3$	
A <sub>e</sub> /ft in <sup>2</sup>	I <sub>e+</sub> in <sup>4</sup> /ft	y <sub>b</sub> in	S <sub>e+</sub> in <sup>3</sup> /ft	I <sub>e-</sub> in <sup>4</sup> /ft	y <sub>b</sub> in	S <sub>e-</sub> in <sup>3</sup> /ft	I <sub>+</sub> in <sup>4</sup> /ft	I <sub>-</sub> in <sup>4</sup> /ft	
24	0.1096	0.1815	0.39	0.1132	0.0765	1.15	0.0665	0.1865	0.1165
22	0.1560	0.2363	0.41	0.1485	0.1043	1.12	0.0935	0.2395	0.1515

**Table 1.8 - Allowable reactions at supports (16" Span-lok hp / SpanSeam):**

Gauge	Condition	Allowable (lbs/ft width)	Factored (lbs/ft width)
24	1- End	266	425
	2- Interior	397	636
22	1- End	401	642
	2- Interior	483	773

Reaction capacities based on a minimum 1.5" web bearing length





**Table 1.9 - Positive (inward) uniform load design values (16" Span-lok hp / SpanSeam panel):**

Gauge	Span	Condition	Positive (Inward) Uniform Load Capacity (lbs/ft <sup>2</sup> ) / Span (ft - in.)						
			2' - 0"	2' - 6"	3' - 0"	3' - 6"	4' - 0"	4' - 6"	5' - 0"
24	Single Span	ASD, W/Ω	266	212	177	152	133	112	90
		LRFD, φW	425	340	283	243	213	177	143
		L/180	-	-	-	-	-	-	-
		L/60	-	-	-	-	-	-	-
	Double Span	ASD, W/Ω	159	127	106	91	79	63	52
		LRFD, φW	254	203	170	145	121	96	79
		L/180 L/60	- -	- -	- -	- -	- -	- -	- -
	Triple Span	ASD, W/Ω	181	144	120	103	90	79	65
		LRFD, φW	289	231	193	165	145	119	97
L/180 L/60		- -	- -	- -	- -	- -	- -	- -	
22	Single Span	ASD, W/Ω	401	321	267	229	185	146	119
		LRFD, φW	642	513	428	367	294	232	188
		L/180	-	-	-	-	-	-	-
		L/60	-	-	-	-	-	-	-
	Double Span	ASD, W/Ω	193	155	129	111	97	86	74
		LRFD, φW	309	247	206	177	155	136	111
		L/180 L/60	- -	- -	- -	- -	- -	- -	- -
	Triple Span	ASD, W/Ω	220	176	147	126	110	98	88
		LRFD, φW	351	281	234	201	176	156	137
L/180 L/60		- -	- -	- -	- -	- -	- -	- -	

Table values denoted by "-" indicate that capacities are limited by panel strength not deflection.



Table 1.10 - Clip/fastener attachment schedule (16", No. 22 gage Span-lok hp / SpanSeam with Standard Clip)

Substrate		Fastener		Attachment Spacing, (ft-in)																	
				1' - 0"		1' - 6"		2' - 0"		2' - 6"		3' - 0"		3' - 6"		4' - 0"		4' - 6"		5' - 0"	
				Panel / Clip Negative (Outward) Uniform Load Capacity, (lbs/ft <sup>2</sup> )																	
				241	381	220	348	199	315	178	282	158	249	137	216	116	183	95	150	74	116
		# per clip	Size	Panel System Negative (Outward) Uniform Load Capacity, (lbs/ft <sup>2</sup> )																	
				ASD	LRFD	ASD	LRFD	ASD	LRFD	ASD	LRFD	ASD	LRFD	ASD	LRFD	ASD	LRFD	ASD	LRFD		
				W/Ω	φW	W/Ω	φW	W/Ω	φW	W/Ω	φW	W/Ω	φW	W/Ω	φW	W/Ω	φW	W/Ω	φW	W/Ω	φW
				W/Ω	φW	W/Ω	φW	W/Ω	φW	W/Ω	φW	W/Ω	φW	W/Ω	φW	W/Ω	φW	W/Ω	φW	W/Ω	φW
Cold Formed Steel (Gr 55 min.)	12ga (.1050")	2	#10	241	381	198	297	148	223	119	178	99	149	85	127	74	111	66	99	59	89
		2	#12	241	381	220	338	169	253	135	203	112	169	96	145	84	127	75	113	67	101
		2	1/4"	241	381	220	348	195	293	156	234	130	195	112	167	98	146	87	130	74	116
	14ga (.0700")	2	#10	198	297	132	198	99	149	79	119	66	99	57	85	49	74	44	66	40	59
		2	#12	225	338	150	225	112	169	90	135	75	113	64	96	56	84	50	75	45	68
		2	1/4"	241	381	174	261	130	195	104	156	87	130	74	112	65	98	58	87	52	78
	16ga (.0590")	2	#10	167	250	111	167	83	125	67	100	56	83	48	71	42	62	37	56	33	50
		2	#12	190	284	126	190	95	142	76	114	63	95	54	81	47	71	42	63	38	57
		2	1/4"	219	329	146	220	110	165	88	132	73	110	63	94	55	82	49	73	44	66
	18ga (.0470")	2	#10	133	200	89	133	66	100	53	80	44	67	38	57	33	50	30	44	27	40
		2	#12	151	227	101	151	76	113	60	91	50	76	43	65	38	57	34	50	30	45
		2	1/4"	175	263	117	175	87	131	70	105	58	88	50	75	44	66	39	58	35	53
Cold Formed Steel (Gr 33 min.)	16ga (.0598")	2	#10	109	163	72	109	54	81	43	65	36	54	31	47	27	41	24	36	22	33
		2	#12	124	185	82	124	62	93	49	74	41	62	35	53	31	46	27	41	25	37
		2	1/4"	143	215	95	143	71	107	57	86	48	72	41	61	36	54	32	48	29	43
	18ga (.0478")	2	#10	87	131	58	87	43	65	35	52	29	44	25	37	22	33	19	29	17	26
		2	#12	99	148	66	99	49	74	39	59	33	49	28	42	25	37	22	33	20	30
		2	1/4"	114	172	76	115	57	86	46	69	38	57	33	49	29	43	25	38	23	34
	20ga (.0359")	2	#10	65	98	43	65	33	49	26	39	22	33	19	28	16	24	14	22	13	20
		2	#12	74	111	49	74	37	56	30	44	25	37	21	32	19	28	16	25	15	22
		2	1/4"	86	129	57	86	43	65	34	52	29	43	25	37	21	32	19	29	17	26
	22ga (.0299")	2	#10	54	82	36	55	27	41	22	33	18	27	16	23	14	20	12	18	11	16
		2	#12	62	93	41	62	31	47	25	37	21	31	18	27	15	23	14	21	12	19
		2	1/4"	71	107	48	72	36	54	29	43	24	36	20	31	18	27	16	24	14	21
Plywood & OSB	15/32"	2	#10	62	83	41	56	31	42	25	33	21	28	18	24	15	21	14	19	12	17
		2	#12	70	95	47	63	35	47	28	38	23	32	20	27	18	24	16	21	14	19
		2	#14	77	104	52	70	39	52	31	42	26	35	22	30	19	26	17	23	15	21
	19/32"	2	#10	78	106	52	71	39	53	31	42	26	35	22	30	20	26	17	24	16	21
		2	#12	89	120	59	80	44	60	36	48	30	40	25	34	22	30	20	27	18	24
		2	#14	98	132	65	88	49	66	39	53	33	44	28	38	24	33	22	29	20	26
	23/32"	2	#10	95	128	63	85	47	64	38	51	32	43	27	36	24	32	21	28	19	26
		2	#12	108	146	72	97	54	73	43	58	36	49	31	42	27	36	24	32	22	29
		2	#14	118	160	79	107	59	80	47	64	39	53	34	46	30	40	26	36	24	32
Lumber (DFL)	1" min	2	#10	156	211	104	141	78	105	62	84	52	70	45	60	39	53	35	47	31	42
		2	#12	177	239	118	160	89	120	71	96	59	80	51	68	44	60	39	53	35	48
		2	#14	195	264	130	176	98	132	78	106	65	88	56	75	49	66	43	59	39	53

Specific Notes (Refer to the General Notes section for other applicable notes):

1. Table accounts for increased loads on fasteners due to the eccentricity of the fasteners relative to the panel seam. The Span-lok hp & SpanSeam panel summary chart at the front of this section provides for development of these fastener load adjustments.

2. Number of clip fasteners can be reduced to (1) if project load requirements can still be met. The tabulated panel system capacities shall be reduced by 40% ( $fastener\ capacity \times Qty=1 \div 1.66$  is 40% of  $fastener\ capacity \times Qty=2 \div 2.0$ ). The fastener hole closest to the panel seam must be used. The Span-lok hp & SpanSeam panel summary chart at the front of this section provides for development of these fastener load adjustments.



**Table 1.11 - Clip/fastener attachment schedules (16", No. 24 gage Span-lok hp / SpanSeam with Standard Clip)**

Substrate		Fastener # per clip Size		Attachment Spacing, (ft-in)																												
				1' - 0"	1' - 6"	2' - 0"	2' - 6"	3' - 0"	3' - 6"	4' - 0"	4' - 6"	5' - 0"	Panel / Clip Negative (Outward) Uniform Load Capacity, (lbs/ft <sup>2</sup> )																			
				190	298	174	273	158	248	142	223	126	198	110	173	94	148	77	123	61	98											
				Panel System Negative (Outward) Uniform Load Capacity, (lbs/ft <sup>2</sup> )																												
				ASD	LRFD	ASD	LRFD	ASD	LRFD	ASD	LRFD	ASD	LRFD	ASD	LRFD	ASD	LRFD	ASD	LRFD													
				W/Ω	φW	W/Ω	φW	W/Ω	φW	W/Ω	φW	W/Ω	φW	W/Ω	φW	W/Ω	φW	W/Ω	φW													
Cold Formed Steel (Gr 55 min.)	12ga (.1050")	2	#10	190	298	174	273	148	223	119	178	99	149	85	127	74	111	66	99	59	89											
		2	#12	190	298	174	273	158	248	135	203	112	169	96	145	84	127	75	113	61	98											
		2	1/4"	190	298	174	273	158	248	142	223	126	195	110	167	94	146	77	123	61	98											
	14ga (.0700")	2	#10	190	297	132	198	99	149	79	119	66	99	57	85	49	74	44	66	40	59											
		2	#12	190	298	150	225	112	169	90	135	75	113	64	96	56	84	50	75	45	68											
		2	1/4"	190	298	174	261	130	195	104	156	87	130	74	112	65	98	58	87	52	78											
	16ga (.0590")	2	#10	167	250	111	167	83	125	67	100	56	83	48	71	42	62	37	56	33	50											
		2	#12	190	284	126	190	95	142	76	114	63	95	54	81	47	71	42	63	38	57											
		2	1/4"	190	298	146	220	110	165	88	132	73	110	63	94	55	82	49	73	44	66											
	18ga (.0470")	2	#10	133	200	89	133	66	100	53	80	44	67	38	57	33	50	30	44	27	40											
		2	#12	151	227	101	151	76	113	60	91	50	76	43	65	38	57	34	50	30	45											
		2	1/4"	175	263	117	175	87	131	70	105	58	88	50	75	44	66	39	58	35	53											
Cold Formed Steel (Gr 33 min.)	16ga (.0598")	2	#10	109	163	72	109	54	81	43	65	36	54	31	47	27	41	24	36	22	33											
		2	#12	124	185	82	124	62	93	49	74	41	62	35	53	31	46	27	41	25	37											
		2	1/4"	143	215	95	143	71	107	57	86	48	72	41	61	36	54	32	48	29	43											
	18ga (.0478")	2	#10	87	131	58	87	43	65	35	52	29	44	25	37	22	33	19	29	17	26											
		2	#12	99	148	66	99	49	74	39	59	33	49	28	42	25	37	22	33	20	30											
		2	1/4"	114	172	76	115	57	86	46	69	38	57	33	49	29	43	25	38	23	34											
	20ga (.0359")	2	#10	65	98	43	65	33	49	26	39	22	33	19	28	16	24	14	22	13	20											
		2	#12	74	111	49	74	37	56	30	44	25	37	21	32	19	28	16	25	15	22											
		2	1/4"	86	129	57	86	43	65	34	52	29	43	25	37	21	32	19	29	17	26											
	22ga (.0299")	2	#10	54	82	36	55	27	41	22	33	18	27	16	23	14	20	12	18	11	16											
		2	#12	62	93	41	62	31	47	25	37	21	31	18	27	15	23	14	21	12	19											
		2	1/4"	71	107	48	72	36	54	29	43	24	36	20	31	18	27	16	24	14	21											
Plywood & OSB	15/32"	2	#10	62	83	41	56	31	42	25	33	21	28	18	24	15	21	14	19	12	17											
		2	#12	70	95	47	63	35	47	28	38	23	32	20	27	18	24	16	21	14	19											
		2	#14	77	104	52	70	39	52	31	42	26	35	22	30	19	26	17	23	15	21											
	19/32"	2	#10	78	106	52	71	39	53	31	42	26	35	22	30	20	26	17	24	16	21											
		2	#12	89	120	59	80	44	60	36	48	30	40	25	34	22	30	20	27	18	24											
		2	#14	98	132	65	88	49	66	39	53	33	44	28	38	24	33	22	29	20	26											
	23/32"	2	#10	95	128	63	85	47	64	38	51	32	43	27	36	24	32	21	28	19	26											
		2	#12	108	146	72	97	54	73	43	58	36	49	31	42	27	36	24	32	22	29											
		2	#14	118	160	79	107	59	80	47	64	39	53	34	46	30	40	26	36	24	32											
Lumber (DFL)	1" min	2	#10	156	211	104	141	78	105	62	84	52	70	45	60	39	53	35	47	31	42											
		2	#12	177	239	118	160	89	120	71	96	59	80	51	68	44	60	39	53	35	48											
		2	#14	190	264	130	176	98	132	78	106	65	88	56	75	49	66	43	59	39	53											

**Specific Notes (Refer to the General Notes section for other applicable notes):**

- Table accounts for increased loads on fasteners due to the eccentricity of the fasteners relative to the panel seam. The Span-lok hp & SpanSeam panel summary chart at the front of this section provides for development of these fastener load adjustments.
- Number of clip fasteners can be reduced to (1) if project load requirements can still be met. The tabulated panel system capacities shall be reduced by 40% ( $fastener\ capacity \times Qty=1 \div 1.66$  is 40% of fastener capacity  $\times Qty=2 \div 2.0$ ). The fastener hole closest to the panel seam must be used. The Span-lok hp & SpanSeam panel summary chart at the front of this section provides for development of these fastener load adjustments.



**Table 1.12 - Clip/fastener attachment schedule (Span-lok hp / SpanSeam with low Clip)**

Substrate	Fastener		Attachment Spacing, (ft-in)																	
	# per clip	Size	1' - 0"	1' - 6"		2' - 0"		2' - 6"		3' - 0"		3' - 6"		4' - 0"		4' - 6"		5' - 0"		
			Panel / Clip Negative (Outward) Uniform Load Capacity, (lbs/ft <sup>2</sup> )																	
			114	182	99	158	86	137	73	117	62	99	52	83	43	68	35	56	28	45
Panel System Negative (Outward) Uniform Load Capacity, (lbs/ft <sup>2</sup> )																				
			ASD	LRFD	ASD	LRFD	ASD	LRFD	ASD	LRFD	ASD	LRFD	ASD	LRFD	ASD	LRFD	ASD	LRFD	ASD	LRFD
			W/Ω	φW	W/Ω	φW	W/Ω	φW	W/Ω	φW	W/Ω	φW	W/Ω	φW	W/Ω	φW	W/Ω	φW	W/Ω	φW
Cold Formed Steel (Gr 55 min.)	12ga (.1050")	2 #10	114	182	99	158	86	137	73	117	62	99	52	83	43	68	35	56	28	45
		2 #12	114	182	99	158	86	137	73	117	62	99	52	83	43	68	35	56	28	45
		2 1/4"	114	182	99	158	86	137	73	117	62	99	52	83	43	68	35	56	28	45
	14ga (.0700")	2 #10	114	182	99	158	86	137	73	117	62	99	52	83	43	68	35	56	28	45
		2 #12	114	182	99	158	86	137	73	117	62	99	52	83	43	68	35	56	28	45
		2 1/4"	114	182	99	158	86	137	73	117	62	99	52	83	43	68	35	56	28	45
	16ga (.0590")	2 #10	114	182	99	158	86	137	73	117	62	99	52	83	43	68	35	56	28	45
		2 #12	114	182	99	158	86	137	73	117	62	99	52	83	43	68	35	56	28	45
		2 1/4"	114	182	99	158	86	137	73	117	62	99	52	83	43	68	35	56	28	45
	18ga (.0470")	2 #10	114	182	99	158	82	123	65	98	54	82	47	70	41	61	35	55	28	45
		2 #12	114	182	99	158	86	137	73	112	62	93	52	80	43	68	35	56	28	45
		2 1/4"	114	182	99	158	86	137	73	117	62	99	52	83	43	68	35	56	28	45
Cold Formed Steel (Gr 33 min.)	16ga (.0598")	2 #10	114	182	89	134	67	100	53	80	45	67	38	57	33	50	30	45	27	40
		2 #12	114	182	99	152	76	114	61	91	51	76	43	65	38	57	34	51	28	45
		2 1/4"	114	182	99	158	86	132	70	106	59	88	50	75	43	66	35	56	28	45
	18ga (.0478")	2 #10	107	161	71	107	53	80	43	64	36	54	31	46	27	40	24	36	21	32
		2 #12	114	182	81	121	61	91	49	73	41	61	35	52	30	45	27	40	24	36
		2 1/4"	114	182	94	141	70	106	56	85	47	70	40	60	35	53	31	47	28	42
	20ga (.0359")	2 #10	80	120	54	80	40	60	32	48	27	40	23	34	20	30	18	27	16	24
		2 #12	91	137	61	91	46	68	37	55	30	46	26	39	23	34	20	30	18	27
		2 1/4"	106	159	70	106	53	79	42	64	35	53	30	45	26	40	23	35	21	32
	22ga (.0299")	2 #10	67	101	45	67	33	50	27	40	22	34	19	29	17	25	15	22	13	20
		2 #12	76	114	51	76	38	57	30	46	25	38	22	33	19	29	17	25	15	23
		2 1/4"	88	132	59	88	44	66	35	53	29	44	25	38	22	33	20	29	18	26
Plywood & OSB	15/32"	2 #10	76	102	51	68	38	51	30	41	25	34	22	29	19	26	17	23	15	20
		2 #12	86	116	58	78	43	58	35	47	29	39	25	33	22	29	19	26	17	23
		2 #14	95	128	63	86	48	64	38	51	32	43	27	37	24	32	21	29	19	26
	19/32"	2 #10	96	130	64	87	48	65	38	52	32	43	27	37	24	33	21	29	19	26
		2 #12	109	148	73	98	55	74	44	59	36	49	31	42	27	37	24	33	22	30
		2 #14	114	162	80	108	60	81	48	65	40	54	34	46	30	41	27	36	24	32
	23/32"	2 #10	114	157	78	105	58	78	47	63	39	52	33	45	29	39	26	35	23	31
		2 #12	114	179	88	119	66	90	53	72	44	60	38	51	33	45	29	40	26	36
		2 #14	114	182	97	131	73	98	58	79	49	66	42	56	36	49	32	44	28	39
Lumber (DFL)	1" min	2 #10	114	182	99	158	86	130	73	104	62	86	52	74	43	65	35	56	28	45
		2 #12	114	182	99	158	86	137	73	117	62	98	52	83	43	68	35	56	28	45
		2 #14	114	182	99	158	86	137	73	117	62	99	52	83	43	68	35	56	28	45

**Specific Notes (Refer to the General Notes section for other applicable notes):**

- Table accounts for increased loads on fasteners due to the eccentricity of the fasteners relative to the panel seam. The Span-lok hp & SpanSeam panel summary chart at the front of this section provides for development of these fastener load adjustments.
- Number of clip fasteners can be reduced to (1) if project load requirements can still be met. The tabulated panel system capacities shall be reduced by 1/2.
- Number of clip fasteners can be increased to (3), and stated capacity up to 50%, with the final capacity not to exceed max Panel/Clip Capacity stated at the top of the chart.



**2.0 - Design Span hp**

**Figure 2.1 - Profile: As installed view shown.**

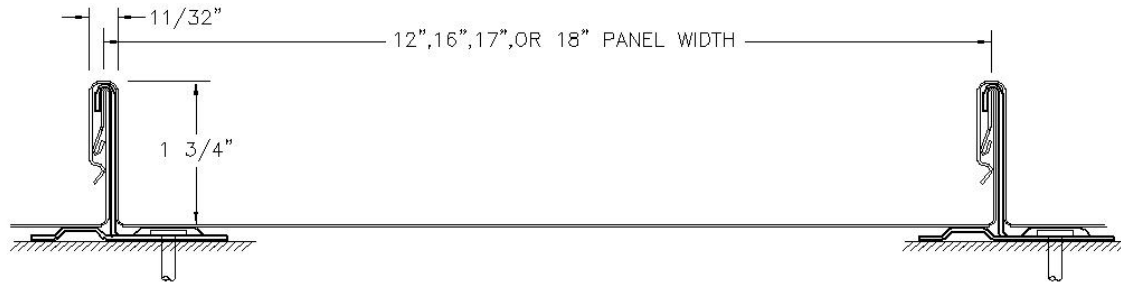

**Table 2.1 - Profile**

<b>Panel Use:</b>	Roof (primary use), wall, fascia
<b>Substrates:</b>	Over spaced supports or solid substrate
<b>Available Gages:</b>	No. 22, 24
<b>Minimum Slope:</b>	3:12 (25 percent)
<b>Load Combination Reduction Available (Ref. Section 5.6)</b>	No
<b>Uninstalled Panel View</b>	

**Table 2.2 - Attachment:**

<b>Clip Name:</b>	Design Span Clip
<b>Clip View:</b>	
<b>Clip Usage:</b>	Over spaced framing or solid substrates
<b>Part #:</b>	#DSPCLP3.5
<b>Panel/ Substrate Gap:</b>	3/16 inch
<b>Thermal Movement:</b>	Unlimited
<b>Fastener Limitations:</b>	Nom. size: ¼ inch max. Head height: 0.120 inch max. Head dia.: ½ inch max.
<b>Recommended Fastener(s):</b>	#10 or #12 pancake head
<b>Fastener Load Adjustments</b> (due to eccentricity of fasteners relative to panel seam):	Per fastener: 2.07 $\Sigma M = 0$ 1.39P = .67R
<b>Associated Bearing Plate:</b>	#BP3HOLE

**Table 2.3 - Section properties (12" Design Span hp panel)**

Gauge	Weight	Base Metal Thickness	Yield Strength	Tensile Strength	Gross Section Properties				
					Area	Moment of Inertia	Distance to N.A. from Bottom	Positive Section Modulus	Negative Section Modulus
	w	t	F <sub>y</sub>	F <sub>u</sub>	A <sub>g</sub>	I <sub>g</sub>	y <sub>b</sub>	S <sub>g+</sub>	S <sub>g-</sub>
	psf	in	ksi	ksi	in <sup>2</sup> /ft	in <sup>4</sup> /ft	in	in <sup>3</sup> /ft	in <sup>3</sup> /ft
24	1.45	0.0232	50	65	0.4162	0.1226	0.35	0.0875	0.3518
22	1.83	0.0294	50	65	0.5249	0.1530	0.35	0.1090	0.4393

Gauge	Effective Section Properties							Uniform Load Only	
	Area	Positive			Negative			I <sub>d</sub> = (2I <sub>e+</sub> +I <sub>g</sub> )/3	
		Moment of Inertia	Distance to N.A. from Bottom	Section Modulus	Moment of Inertia	Distance to N.A. from Bottom	Section Modulus		
A <sub>e</sub> /ft in <sup>2</sup>	I <sub>e+</sub> in <sup>4</sup> /ft	y <sub>b</sub> in	S <sub>e+</sub> in <sup>3</sup> /ft	I <sub>e-</sub> in <sup>4</sup> /ft	y <sub>b</sub> in	S <sub>e-</sub> in <sup>3</sup> /ft	I <sub>+</sub> in <sup>4</sup> /ft	I <sub>-</sub> in <sup>4</sup> /ft	
24	0.1350	0.1165	0.33	0.0820	0.0530	0.85	0.0586	0.1185	0.0762
22	0.1913	0.1518	0.35	0.1080	0.0730	0.80	0.0771	0.1522	0.0997





**Table 2.4 - Allowable reactions at supports (12" Design Span hp):**

Gauge	Condition	Allowable (lbs/ft width)	Factored (lbs/ft width)
24	1- End	412	660
	2- Interior	1005	1610
22	1- End	588	942
	2- Interior	1416	2267

Reaction capacities based on a minimum 1.5" web bearing length

**Table 2.5 - Positive (inward) uniform load design values (12" Design Span hp):**

Gauge	Span	Condition	Positive (Inward) Uniform Load Capacity (lbs/ft <sup>2</sup> ) / Span (ft - in.)						
			2' - 0"	2' - 6"	3' - 0"	3' - 6"	4' - 0"	4' - 6"	5' - 0"
24	Single Span	ASD, W/Ω	409	262	182	134	102	81	65
		LRFD, φW	649	415	289	212	162	128	104
		L/180 L/60	-	-	-	-	-	-	-
	Double Span	ASD, W/Ω	285	184	128	94	72	57	46
		LRFD, φW	429	277	193	141	109	85	70
		L/180 L/60	-	-	-	-	-	-	-
	Triple Span	ASD, W/Ω	353	228	160	118	90	71	58
		LRFD, φW	531	343	241	177	136	107	87
		L/180 L/60	-	-	-	-	-	-	-
22	Single Span	ASD, W/Ω	539	345	240	176	135	106	86
		LRFD, φW	855	547	380	279	214	169	137
		L/180 L/60	-	-	-	-	-	-	-
	Double Span	ASD, W/Ω	377	243	169	124	96	76	61
		LRFD, φW	568	365	255	187	144	114	92
		L/180 L/60	-	-	-	-	-	-	-
	Triple Span	ASD, W/Ω	468	302	211	155	119	94	76
		LRFD, φW	704	455	317	233	180	142	115
		L/180 L/60	-	-	-	-	-	-	-

Table values denoted by "-" indicate that capacities are limited by panel strength not deflection.



**Table 2.6 - Clip/fastener attachment schedules (12", No. 22 & 24 gage Design Span hp):**

Substrate		Fastener		Attachment Spacing, (ft-in)																	
		# per clip	Size	1' - 0"		1' - 6"		2' - 0"		2' - 6"		3' - 0"		3' - 6"		4' - 0"		4' - 6"		5' - 0"	
				Panel / Clip Negative (Outward) Uniform Load Capacity, (lbs/ft <sup>2</sup> )																	
				82	123	76	115	71	106	67	101	63	95	59	89	56	83	52	78	48	72
				Panel System Negative (Outward) Uniform Load Capacity, (lbs/ft <sup>2</sup> )																	
				ASD	LRFD	ASD	LRFD	ASD	LRFD	ASD	LRFD	ASD	LRFD	ASD	LRFD	ASD	LRFD	ASD	LRFD	ASD	LRFD
				W/Ω	φW	W/Ω	φW	W/Ω	φW	W/Ω	φW	W/Ω	φW	W/Ω	φW	W/Ω	φW	W/Ω	φW	W/Ω	φW
Cold Formed Steel (Gr 55 min.)	12ga (.1050")	2	#10	82	123	76	115	71	106	67	101	63	95	59	89	56	83	52	78	48	72
		2	#12	82	123	76	115	71	106	67	101	63	95	59	89	56	83	52	78	48	72
	14ga (.0700")	2	#10	82	123	76	115	71	106	67	101	63	95	59	89	56	83	52	78	48	72
		2	#12	82	123	76	115	71	106	67	101	63	95	59	89	56	83	52	78	48	72
	16ga (.0590")	2	#10	82	123	76	115	71	106	67	101	63	95	59	89	54	80	48	71	43	64
		2	#12	82	123	76	115	71	106	67	101	63	95	59	89	56	83	52	78	48	72
Cold Formed Steel (Gr 33 min.)	18ga (.0470")	2	#10	82	123	76	115	71	106	67	101	57	86	49	73	43	64	38	57	34	51
		2	#12	82	123	76	115	71	106	67	101	63	95	56	83	49	73	43	65	39	58
	16ga (.0598")	2	#10	82	123	76	115	70	105	56	84	47	70	40	60	35	52	31	47	28	42
		2	#12	82	123	76	115	71	106	64	95	53	80	45	68	40	60	35	53	32	48
	18ga (.0478")	2	#10	82	123	75	112	56	84	45	67	37	56	32	48	28	42	25	37	22	34
		2	#12	82	123	76	115	64	95	51	76	42	63	36	54	32	48	28	42	25	38
Plywood & OSB	20ga (.0359")	2	#10	82	123	56	84	42	63	34	50	28	42	24	36	21	31	19	28	17	25
		2	#12	82	123	64	95	48	71	38	57	32	48	27	41	24	36	21	32	19	29
	22ga (.0299")	2	#10	70	105	47	70	35	53	28	42	23	35	20	30	17	26	16	23	14	21
		2	#12	80	120	53	80	40	60	32	48	27	40	23	34	20	30	18	27	16	24
	15/32"	2	#10	79	107	53	71	40	54	32	43	26	36	23	31	20	27	18	24	16	21
		2	#12	82	122	60	81	45	61	36	49	30	41	26	35	23	30	20	27	18	24
Lumber (DFL)	19/32"	2	#10	82	123	67	91	50	68	40	54	34	45	29	39	25	34	22	30	20	27
		2	#12	82	123	76	103	57	77	46	62	38	52	33	44	29	39	25	34	23	31
Lumber (DFL)	23/32"	2	#10	82	123	76	110	61	82	49	66	41	55	35	47	30	41	27	37	24	33
		2	#12	82	123	76	115	69	94	55	75	46	62	40	54	35	47	31	42	28	37
Lumber (DFL)	1" min	2	#10	82	123	76	115	71	106	67	101	63	90	57	78	50	68	45	60	40	54
		2	#12	82	123	76	115	71	106	67	101	63	95	59	88	56	77	51	68	46	62

**Specific Notes (Refer to the General Notes section for other applicable notes):**

1. Table accounts for increased loads on fasteners due to the eccentricity of the fasteners relative to the panel seam. The Design Span hp panel summary chart at the front of this section provides for development of these fastener load adjustments.

2. Number of clip fasteners can be reduced to (1) if project load requirements can still be met. The tabulated panel system capacities shall be reduced by 1/2.

3. Number of clip fasteners can be increased to (3), and stated capacity up to 50%, with the final capacity not to exceed max Panel/Clip Capacity stated at the top of the chart.



**Table 2.7 - Section properties (16" Design Span hp):**

Gauge	Weight	Base Metal Thickness	Yield Strength	Tensile Strength	Gross Section Properties				
					Area	Moment of Inertia	Distance to N.A. from Bottom	Positive Section Modulus	Negative Section Modulus
	w	t	Fy	Fu	A <sub>g</sub>	I <sub>g</sub>	y <sub>b</sub>	S <sub>g+</sub>	S <sub>g-</sub>
	psf	in	ksi	ksi	in <sup>2</sup> /ft	in <sup>4</sup> /ft	in	in <sup>3</sup> /ft	in <sup>3</sup> /ft
24	1.34	0.0232	50	65	0.3817	0.0983	0.29	0.0673	0.3428
22	1.68	0.0294	50	65	0.4819	0.1223	0.29	0.0838	0.4274

Gauge	Effective Section Properties							Uniform Load Only	
	Area	Positive			Negative			I <sub>d</sub> = (2I <sub>e</sub> +I <sub>g</sub> )/3	
		Moment of Inertia	Distance to N.A. from Bottom	Section Modulus	Moment of Inertia	Distance to N.A. from Bottom	Section Modulus		
A <sub>e</sub> /ft in <sup>2</sup>	I <sub>e+</sub> in <sup>4</sup> /ft	y <sub>b</sub> in	S <sub>e+</sub> in <sup>3</sup> /ft	I <sub>e-</sub> in <sup>4</sup> /ft	y <sub>b</sub> in	S <sub>e-</sub> in <sup>3</sup> /ft	I <sub>d+</sub> in <sup>4</sup> /ft	I <sub>d-</sub> in <sup>4</sup> /ft	
24	0.1013	0.0923	0.27	0.0624	0.0398	0.84	0.0440	0.0943	0.0593
22	0.1437	0.1208	0.28	0.0825	0.0548	0.80	0.0580	0.1213	0.0773

**Table 2.8 - Allowable reactions at supports (16" Design Span hp):**

Gauge	Condition	Allowable (lbs/ft width)	Factored (lbs/ft width)
24	1- End	309	495
	2- Interior	754	1207
22	1- End	492	788
	2- Interior	612	980

Reaction capacities based on a minimum 1.5" web bearing length



**Table 2.9 - Positive (inward) uniform load design values (16" Design Span hp):**

Gauge	Span	Condition	Positive (Inward) Uniform Load Capacity (lbs/ft <sup>2</sup> ) / Span (ft. - in.)						
			2' - 0"	2' - 6"	3' - 0"	3' - 6"	4' - 0"	4' - 6"	5' - 0"
24	Single Span	ASD, W/Ω	309	199	138	102	78	62	50
		LRFD, φW	494	316	220	161	124	98	79
		L/180	-	-	-	-	-	-	-
		L/60	-	-	-	-	-	-	-
	Double Span	ASD, W/Ω	214	138	96	71	54	43	34
		LRFD, φW	322	208	144	107	82	65	52
		L/180	-	-	-	-	-	-	-
		L/60	-	-	-	-	-	-	-
	Triple Span	ASD, W/Ω	265	171	119	88	67	53	43
LRFD, φW		399	258	180	132	102	80	65	
L/180		-	-	-	-	-	-	-	
L/60		-	-	-	-	-	-	-	
22	Single Span	ASD, W/Ω	412	263	183	134	103	81	66
		LRFD, φW	653	418	290	213	163	129	105
		L/180	-	-	-	-	-	-	-
		L/60	-	-	-	-	-	-	-
	Double Span	ASD, W/Ω	245	183	127	93	72	57	45
		LRFD, φW	392	275	192	140	108	85	68
		L/180	-	-	-	-	-	-	-
		L/60	-	-	-	-	-	-	-
	Triple Span	ASD, W/Ω	278	223	158	117	90	70	57
LRFD, φW		445	342	238	176	135	106	86	
L/180		-	-	-	-	-	-	-	
L/60		-	-	-	-	-	-	-	

Table values denoted by "-" indicate that capacities are limited by panel strength not deflection.



**Table 2.10 - Clip/fastener attachment schedule (16", No. 22 gage Design Span hp):**

Substrate		Fastener		Attachment Spacing, (ft-in)																		
		# per clip	Size	1' - 0"	1' - 6"	2' - 0"	2' - 6"	3' - 0"	3' - 6"	4' - 0"	4' - 6"	5' - 0"										
				Panel / Clip Negative (Outward) Uniform Load Capacity, (lbs/ft <sup>2</sup> )																		
				74	112	66	99	58	87	49	74	49	73	48	72	47	71	47	70	46	69	
Panel System Negative (Outward) Uniform Load Capacity, (lbs/ft <sup>2</sup> )																						
				ASD	LRFD	ASD	LRFD	ASD	LRFD	ASD	LRFD	ASD	LRFD	ASD	LRFD	ASD	LRFD	ASD	LRFD			
				W/Ω	φW	W/Ω	φW	W/Ω	φW	W/Ω	φW	W/Ω	φW	W/Ω	φW	W/Ω	φW	W/Ω	φW			
Cold Formed Steel (Gr 55 min.)	12ga (.1050")	2	#10	74	112	66	99	58	87	49	74	49	73	48	72	47	71	47	70	46	69	
		2	#12	74	112	66	99	58	87	49	74	49	73	48	72	47	71	47	70	46	69	
	14ga (.0700")	2	#10	74	112	66	99	58	87	49	74	49	73	48	72	47	71	42	64	38	57	
		2	#12	74	112	66	99	58	87	49	74	49	73	48	72	47	71	47	70	43	65	
	16ga (.0590")	2	#10	74	112	66	99	58	87	49	74	49	73	46	69	40	60	36	54	32	48	
		2	#12	74	112	66	99	58	87	49	74	49	73	48	72	46	69	41	61	37	55	
	18ga (.0470")	2	#10	74	112	66	99	58	87	49	74	43	64	37	55	32	48	29	43	26	39	
		2	#12	74	112	66	99	58	87	49	74	49	73	42	63	36	55	32	49	29	44	
Cold Formed Steel (Gr 33 min.)	16ga (.0598")	2	#10	74	112	66	99	52	79	42	63	35	52	30	45	26	39	23	35	21	31	
		2	#12	74	112	66	99	58	87	48	72	40	60	34	51	30	45	27	40	24	36	
	18ga (.0478")	2	#10	74	112	56	84	42	63	34	50	28	42	24	36	21	32	19	28	17	25	
		2	#12	74	112	64	95	48	71	38	57	32	48	27	41	24	36	21	32	19	29	
	20ga (.0359")	2	#10	63	94	42	63	32	47	25	38	21	31	18	27	16	24	14	21	13	19	
		2	#12	72	107	48	71	36	54	29	43	24	36	20	31	18	27	16	24	14	21	
Plywood & OSB	15/32"	2	#10	60	80	40	54	30	40	24	32	20	27	17	23	15	20	13	18	12	16	
		2	#12	68	91	45	61	34	46	27	37	23	30	19	26	17	23	15	20	14	18	
	19/32"	2	#10	74	102	50	68	38	51	30	41	25	34	22	29	19	26	17	23	15	20	
		2	#12	74	112	57	77	43	58	34	46	29	39	25	33	21	29	19	26	17	23	
	23/32"	2	#10	74	112	61	82	46	62	37	49	30	41	26	35	23	31	20	27	18	25	
		2	#12	74	112	66	94	52	70	42	56	35	47	30	40	26	35	23	31	21	28	
Lumber (DFL)	1" min	2	#10	74	112	66	99	58	87	49	74	49	68	43	58	38	51	33	45	30	41	
		2	#12	74	112	66	99	58	87	49	74	49	73	48	66	43	58	38	51	34	46	

**Specific Notes (Refer to the General Notes section for other applicable notes):**

1. Table accounts for increased loads on fasteners due to the eccentricity of the fasteners relative to the panel seam. The Design Span hp panel summary chart at the front of this section provides for development of these fastener load adjustments.
2. Number of clip fasteners can be reduced to (1) if project load requirements can still be met. The tabulated panel system capacities shall be reduced by 1/2.
3. Number of clip fasteners can be increased to (3), and stated capacity up to 50%, with the final capacity not to exceed max Panel/Clip Capacity stated at the top of the chart.



**Table 2.11 - Clip/fastener attachment schedule (16", No. 24 gage Design Span hp):**

Substrate		Fastener		Attachment Spacing, (ft-in)																					
		# per clip	Size	1' - 0"	1' - 6"	2' - 0"	2' - 6"	3' - 0"	3' - 6"	4' - 0"	4' - 6"	5' - 0"	Panel / Clip Negative (Outward) Uniform Load Capacity, (lbs/ft <sup>2</sup> )												
				49	73	42	64	36	54	30	44	29	44	29	44	29	43	28	43	28	42				
Panel System Negative (Outward) Uniform Load Capacity, (lbs/ft <sup>2</sup> )																									
				ASD	LRFD	ASD	LRFD	ASD	LRFD	ASD	LRFD	ASD	LRFD	ASD	LRFD	ASD	LRFD	ASD	LRFD						
				W/Ω	φW	W/Ω	φW	W/Ω	φW	W/Ω	φW	W/Ω	φW	W/Ω	φW	W/Ω	φW	W/Ω	φW						
Cold Formed Steel (Gr 55 min.)	12ga (.1050")	2	#10	49	73	42	64	36	54	30	44	29	44	29	44	29	43	28	43	28	42				
		2	#12	49	73	42	64	36	54	30	44	29	44	29	44	29	43	28	43	28	42				
	14ga (.0700")	2	#10	49	73	42	64	36	54	30	44	29	44	29	44	29	43	28	43	28	42				
		2	#12	49	73	42	64	36	54	30	44	29	44	29	44	29	43	28	43	28	42				
	16ga (.0590")	2	#10	49	73	42	64	36	54	30	44	29	44	29	44	29	43	28	43	28	42				
		2	#12	49	73	42	64	36	54	30	44	29	44	29	44	29	43	28	43	28	42				
	18ga (.0470")	2	#10	49	73	42	64	36	54	30	44	29	44	29	44	29	43	28	43	26	39				
		2	#12	49	73	42	64	36	54	30	44	29	44	29	44	29	43	28	43	28	42				
Cold Formed Steel (Gr 33 min.)	16ga (.0598")	2	#10	49	73	42	64	36	54	30	44	29	44	29	44	26	39	23	35	21	31				
		2	#12	49	73	42	64	36	54	30	44	29	44	29	44	29	43	27	40	24	36				
	18ga (.0478")	2	#10	49	73	42	64	36	54	30	44	28	42	24	36	21	32	19	28	17	25				
		2	#12	49	73	42	64	36	54	30	44	29	44	27	41	24	36	21	32	19	29				
	20ga (.0359")	2	#10	49	73	42	63	32	47	25	38	21	31	18	27	16	24	14	21	13	19				
		2	#12	49	73	42	64	36	54	29	43	24	36	20	31	18	27	16	24	14	21				
22ga (.0299")	2	#10	49	73	35	53	26	39	21	32	17	26	15	23	13	20	12	18	10	16					
	2	#12	49	73	40	60	30	45	24	36	20	30	17	26	15	22	13	20	12	18					
Plywood & OSB	15/32"	2	#10	49	73	40	54	30	40	24	32	20	27	17	23	15	20	13	18	12	16				
		2	#12	49	73	42	61	34	46	27	37	23	30	19	26	17	23	15	20	14	18				
	19/32"	2	#10	49	73	42	64	36	51	30	41	25	34	22	29	19	26	17	23	15	20				
		2	#12	49	73	42	64	36	54	30	44	29	39	25	33	21	29	19	26	17	23				
23/32"	2	#10	49	73	42	64	36	54	30	44	29	41	26	35	23	31	20	27	18	25					
	2	#12	49	73	42	64	36	54	30	44	29	44	29	40	26	35	23	31	21	28					
Lumber (DFL)	1" min	2	#10	49	73	42	64	36	54	30	44	29	44	29	44	29	43	28	43	28	41				
		2	#12	49	73	42	64	36	54	30	44	29	44	29	44	29	43	28	43	28	42				

**Specific Notes (Refer to the General Notes section for other applicable notes):**

1. Table accounts for increased loads on fasteners due to the eccentricity of the fasteners relative to the panel seam. The Design Span hp panel summary chart at the front of this section provides for development of these fastener load adjustments.
2. Number of clip fasteners can be reduced to (1) if project load requirements can still be met. The tabulated panel system capacities shall be reduced by 1/2.
3. Number of clip fasteners can be increased to (3), and stated capacity up to 50%, with the final capacity not to exceed max Panel/Clip Capacity stated at the top of the chart.





**Table 2.12 - Section properties (17" Design Span hp):**

Gauge	Weight	Base Metal Thickness	Yield Strength	Tensile Strength	Gross Section Properties				
					Area	Moment of Inertia	Distance to N.A. from Bottom	Positive Section Modulus	Negative Section Modulus
	w	t	Fy	Fu	A <sub>g</sub>	I <sub>g</sub>	y <sub>b</sub>	S <sub>g+</sub>	S <sub>g-</sub>
	psf	in	ksi	ksi	in <sup>2</sup> /ft	in <sup>4</sup> /ft	in	in <sup>3</sup> /ft	in <sup>3</sup> /ft
24	1.31	0.0232	50	65	0.3756	0.0939	0.28	0.0636	0.3411
22	1.65	0.0294	50	65	0.4743	0.1172	0.28	0.0792	0.4250

Gauge	Effective Section Properties							Uniform Load Only	
	Area	Positive			Negative			I <sub>d</sub> = (2I <sub>e</sub> +I <sub>g</sub> )/3	
		Moment of Inertia	Distance to N.A. from Bottom	Section Modulus	Moment of Inertia	Distance to N.A. from Bottom	Section Modulus		
	A <sub>e</sub> /ft	I <sub>e+</sub>	y <sub>b</sub>	S <sub>e+</sub>	I <sub>e-</sub>	y <sub>b</sub>	S <sub>e-</sub>	I+	I-
	in <sup>2</sup>	in <sup>4</sup> /ft	in	in <sup>3</sup> /ft	in <sup>4</sup> /ft	in	in <sup>3</sup> /ft	in <sup>4</sup> /ft	in <sup>4</sup> /ft
24	0.0954	0.0882	0.26	0.0589	0.0374	0.84	0.0414	0.0901	0.0562
22	0.1352	0.1151	0.27	0.0779	0.0515	0.80	0.0546	0.1158	0.0734

**Table 2.13 - Allowable reactions at supports (17" Design Span hp):**

Gauge	Condition	Allowable (lbs/ft width)	Factored (lbs/ft width)
24	1- End	291	466
	2- Interior	710	1136
22	1- End	463	742
	2- Interior	576	922

Reaction capacities based on a minimum 1.5" web bearing length



**Table 2.14 - Positive (inward) uniform load design values (17" Design Span hp):**

Gauge	Span	Condition	Positive (Inward) Uniform Load Capacity (lbs/ft <sup>2</sup> ) / Span (ft. - in.)						
			2' - 0"	2' - 6"	3' - 0"	3' - 6"	4' - 0"	4' - 6"	5' - 0"
24	Single Span	ASD, W/Ω	291	188	131	96	73	58	47
		LRFD, φW	466	298	207	152	117	92	75
		L/180 L/60	-	-	-	-	-	-	-
	Double Span	ASD, W/Ω	201	129	90	66	51	40	32
		LRFD, φW	303	195	136	100	76	60	49
		L/180 L/60	-	-	-	-	-	-	-
	Triple Span	ASD, W/Ω	249	162	113	83	64	50	41
		LRFD, φW	375	243	170	124	96	75	62
		L/180 L/60	-	-	-	-	-	-	-
22	Single Span	ASD, W/Ω	389	249	173	127	97	77	62
		LRFD, φW	616	394	274	201	154	122	99
		L/180 L/60	-	-	-	-	-	-	-
	Double Span	ASD, W/Ω	230	171	119	88	67	53	43
		LRFD, φW	369	258	180	132	101	80	64
		L/180 L/60	-	-	-	-	-	-	-
	Triple Span	ASD, W/Ω	262	209	149	110	84	66	54
		LRFD, φW	419	322	225	165	126	100	81
		L/180 L/60	-	-	-	-	-	-	-

Table values denoted by "-" indicate that capacities are limited by panel strength not deflection.



**Table 2.15 - Clip/fastener attachment schedules (17" & 18", No. 22 gage Design Span hp):**

Substrate		Fastener		Attachment Spacing, (ft-in)																	
		# per clip	Size	1' - 0"	1' - 6"	2' - 0"	2' - 6"	3' - 0"	3' - 6"	4' - 0"	4' - 6"	5' - 0"									
				Panel / Clip Negative (Outward) Uniform Load Capacity, (lbs/ft <sup>2</sup> )																	
				67	100	59	88	51	77	43	65	43	64	42	63	42	63	41	62	41	61
Panel System Negative (Outward) Uniform Load Capacity, (lbs/ft <sup>2</sup> )																					
				ASD	LRFD	ASD	LRFD	ASD	LRFD	ASD	LRFD	ASD	LRFD	ASD	LRFD	ASD	LRFD	ASD	LRFD		
				W/Ω	φW	W/Ω	φW	W/Ω	φW	W/Ω	φW	W/Ω	φW	W/Ω	φW	W/Ω	φW	W/Ω	φW		
Cold Formed Steel (Gr 55 min.)	12ga (.1050")	2	#10	67	100	59	88	51	77	43	65	43	64	42	63	42	63	41	62	41	61
		2	#12	67	100	59	88	51	77	43	65	43	64	42	63	42	63	41	62	41	61
	14ga (.0700")	2	#10	67	100	59	88	51	77	43	65	43	64	42	63	42	63	38	57	34	51
		2	#12	67	100	59	88	51	77	43	65	43	64	42	63	42	63	41	62	39	58
	16ga (.0590")	2	#10	67	100	59	88	51	77	43	65	43	64	41	61	36	54	32	48	29	43
		2	#12	67	100	59	88	51	77	43	65	43	64	42	63	41	61	36	54	33	49
Cold Formed Steel (Gr 33 min.)	18ga (.0470")	2	#10	67	100	59	88	51	77	43	65	38	57	33	49	29	43	25	38	23	34
		2	#12	67	100	59	88	51	77	43	65	43	64	37	56	32	49	29	43	26	39
	16ga (.0598")	2	#10	67	100	59	88	47	70	37	56	31	47	27	40	23	35	21	31	19	28
		2	#12	67	100	59	88	51	77	42	64	35	53	30	45	27	40	24	35	21	32
	18ga (.0478")	2	#10	67	100	50	75	37	56	30	45	25	37	21	32	19	28	17	25	15	22
		2	#12	67	100	57	85	42	63	34	51	28	42	24	36	21	32	19	28	17	25
Plywood & OSB	20ga (.0359")	2	#10	56	84	37	56	28	42	22	33	19	28	16	24	14	21	12	19	11	17
		2	#12	64	95	42	64	32	48	25	38	21	32	18	27	16	24	14	21	13	19
	22ga (.0299")	2	#10	47	70	31	47	23	35	19	28	16	23	13	20	12	18	10	16	9	14
		2	#12	53	80	35	53	27	40	21	32	18	27	15	23	13	20	12	18	11	16
Lumber (DFL)	15/32"	2	#10	53	71	35	48	26	36	21	29	18	24	15	20	13	18	12	16	11	14
		2	#12	60	81	40	54	30	41	24	32	20	27	17	23	15	20	13	18	12	16
	19/32"	2	#10	67	91	45	61	34	45	27	36	22	30	19	26	17	23	15	20	13	18
		2	#12	67	100	51	69	38	52	31	41	25	34	22	29	19	26	17	23	15	21
Lumber (DFL)	23/32"	2	#10	67	100	54	73	41	55	32	44	27	37	23	31	20	27	18	24	16	22
		2	#12	67	100	59	83	46	62	37	50	31	42	26	36	23	31	21	28	18	25
Lumber (DFL)	1" min	2	#10	67	100	59	88	51	77	43	65	43	60	38	52	33	45	30	40	27	36
		2	#12	67	100	59	88	51	77	43	65	43	64	42	59	38	51	34	46	30	41

**Specific Notes (Refer to the General Notes section for other applicable notes):**

1. Table accounts for increased loads on fasteners due to the eccentricity of the fasteners relative to the panel seam. The Design Span hp panel summary chart at the front of this section provides for development of these fastener load adjustments.
2. Number of clip fasteners can be reduced to (1) if project load requirements can still be met. The tabulated panel system capacities shall be reduced by 1/2.
3. Number of clip fasteners can be increased to (3), and stated capacity up to 50%, with the final capacity not to exceed max Panel/Clip Capacity stated at the top of the chart.



**Table 2.16 - Clip/fastener attachment schedules (17" & 18", 24 gage Design Span hp):**

Substrate		Fastener		Attachment Spacing, (ft-in)																	
				1' - 0"		1' - 6"		2' - 0"		2' - 6"		3' - 0"		3' - 6"		4' - 0"		4' - 6"		5' - 0"	
				Panel / Clip Negative (Outward) Uniform Load Capacity, (lbs/ft <sup>2</sup> )																	
				48	74	42	64	35	55	29	45	29	45	28	44	28	43	28	43	27	42
Panel System Negative (Outward) Uniform Load Capacity, (lbs/ft <sup>2</sup> )																					
ASD	LRFD	ASD	LRFD	ASD	LRFD	ASD	LRFD	ASD	LRFD	ASD	LRFD	ASD	LRFD	ASD	LRFD	ASD	LRFD	ASD	LRFD		
W/Ω	φW	W/Ω	φW	W/Ω	φW	W/Ω	φW	W/Ω	φW	W/Ω	φW	W/Ω	φW	W/Ω	φW	W/Ω	φW	W/Ω	φW		
Cold Formed Steel (Gr 55 min.)	12ga (.1050")	2	#10	48	74	42	64	35	55	29	45	29	45	28	44	28	43	27	42		
		2	#12	48	74	42	64	35	55	29	45	29	45	28	44	28	43	27	42		
	14ga (.0700")	2	#10	48	74	42	64	35	55	29	45	29	45	28	44	28	43	27	42		
		2	#12	48	74	42	64	35	55	29	45	29	45	28	44	28	43	27	42		
	16ga (.0590")	2	#10	48	74	42	64	35	55	29	45	29	45	28	44	28	43	27	42		
		2	#12	48	74	42	64	35	55	29	45	29	45	28	44	28	43	27	42		
	18ga (.0470")	2	#10	48	74	42	64	35	55	29	45	29	45	28	44	28	43	25	38	23	34
		2	#12	48	74	42	64	35	55	29	45	29	45	28	44	28	43	28	43	26	39
Cold Formed Steel (Gr 33 min.)	16ga (.0598")	2	#10	48	74	42	64	35	55	29	45	29	45	27	40	23	35	21	31	19	28
		2	#12	48	74	42	64	35	55	29	45	29	45	28	44	27	40	24	35	21	32
	18ga (.0478")	2	#10	48	74	42	64	35	55	29	45	25	37	21	32	19	28	17	25	15	22
		2	#12	48	74	42	64	35	55	29	45	28	42	24	36	21	32	19	28	17	25
	20ga (.0359")	2	#10	48	74	37	56	28	42	22	33	19	28	16	24	14	21	12	19	11	17
		2	#12	48	74	42	64	32	48	25	38	21	32	18	27	16	24	14	21	13	19
	22ga (.0299")	2	#10	47	70	31	47	23	35	19	28	16	23	13	20	12	18	10	16	9	14
		2	#12	48	74	35	53	27	40	21	32	18	27	15	23	13	20	12	18	11	16
Plywood & OSB	15/32"	2	#10	48	71	35	48	26	36	21	29	18	24	15	20	13	18	12	16	11	14
		2	#12	48	74	40	54	30	41	24	32	20	27	17	23	15	20	13	18	12	16
	19/32"	2	#10	48	74	42	61	34	45	27	36	22	30	19	26	17	23	15	20	13	18
		2	#12	48	74	42	64	35	52	29	41	25	34	22	29	19	26	17	23	15	21
	23/32"	2	#10	48	74	42	64	35	55	29	44	27	37	23	31	20	27	18	24	16	22
		2	#12	48	74	42	64	35	55	29	45	29	42	26	36	23	31	21	28	18	25
Lumber (DFL)	1" min	2	#10	48	74	42	64	35	55	29	45	29	45	28	44	28	43	28	40	27	36
		2	#12	48	74	42	64	35	55	29	45	29	45	28	44	28	43	28	43	27	41

**Specific Notes (Refer to the General Notes section for other applicable notes):**

1. Table accounts for increased loads on fasteners due to the eccentricity of the fasteners relative to the panel seam. The Design Span hp panel summary chart at the front of this section provides for development of these fastener load adjustments.
2. Number of clip fasteners can be reduced to (1) if project load requirements can still be met. The tabulated panel system capacities shall be reduced by 1/2.
3. Number of clip fasteners can be increased to (3), and stated capacity up to 50%, with the final capacity not to exceed max Panel/Clip Capacity stated at the top of the chart.



**Table 2.17 - Section properties (18" Design Span hp):**

Gauge	Weight	Base Metal Thickness	Yield Strength	Tensile Strength	Gross Section Properties				
					Area	Moment of Inertia	Distance to N.A. from Bottom	Positive Section Modulus	Negative Section Modulus
	w psf	t in	F <sub>y</sub> ksi	F <sub>u</sub> ksi	A <sub>g</sub> in <sup>2</sup> /ft	I <sub>g</sub> in <sup>4</sup> /ft	y <sub>b</sub> in	S <sub>g+</sub> in <sup>3</sup> /ft	S <sub>g-</sub> in <sup>3</sup> /ft
24	1.30	0.0232	50	65	0.3702	0.0893	0.26	0.0603	0.3394
22	1.63	0.0294	50	65	0.4675	0.1113	0.26	0.0751	0.4228

Gauge	Effective Section Properties							Uniform Load Only	
	Area	Positive			Negative			I <sub>d</sub> = (2I <sub>e</sub> +I <sub>g</sub> )/3	
		Moment of Inertia	Distance to N.A. from Bottom	Section Modulus	Moment of Inertia	Distance to N.A. from Bottom	Section Modulus		
A <sub>e</sub> /ft in <sup>2</sup>	I <sub>e+</sub> in <sup>4</sup> /ft	y <sub>b</sub> in	S <sub>e+</sub> in <sup>3</sup> /ft	I <sub>e-</sub> in <sup>4</sup> /ft	y <sub>b</sub> in	S <sub>e-</sub> in <sup>3</sup> /ft	I <sub>+</sub> in <sup>4</sup> /ft	I <sub>-</sub> in <sup>4</sup> /ft	
24	0.0901	0.0840	0.25	0.0557	0.0353	0.84	0.0391	0.0858	0.0533
22	0.1278	0.1100	0.26	0.0737	0.0487	0.80	0.0515	0.1104	0.0696

**Table 2.18 - Allowable reactions at supports (18" Design Span hp):**

Gauge	Condition	Allowable (lbs/ft width)	Factored (lbs/ft width)
24	1- End	275	440
	2- Interior	670	1073
22	1- End	437	701
	2- Interior	544	871

Reaction capacities based on a minimum 1.5" web bearing length



**Table 2.19 - Positive (inward) uniform load design values (18" Design Span hp):**

Gauge	Span	Condition	Positive (Inward) Uniform Load Capacity (lbs/ft <sup>2</sup> ) / Span (ft - in.)						
			2' - 0"	2' - 6"	3' - 0"	3' - 6"	4' - 0"	4' - 6"	5' - 0"
24	Single Span	ASD, W/Ω	275	178	124	91	70	55	44
		LRFD, φW	440	282	196	144	110	87	71
		L/180	-	-	-	-	-	-	-
		L/60	-	-	-	-	-	-	-
	Double Span	ASD, W/Ω	190	123	86	62	48	38	31
		LRFD, φW	287	185	129	94	73	58	47
		L/180	-	-	-	-	-	-	-
		L/60	-	-	-	-	-	-	-
	Triple Span	ASD, W/Ω	236	152	107	78	60	47	38
LRFD, φW		355	229	161	118	90	71	58	
L/180		-	-	-	-	-	-	-	
L/60		-	-	-	-	-	-	-	
22	Single Span	ASD, W/Ω	368	235	164	120	92	73	59
		LRFD, φW	584	374	259	191	146	115	93
		L/180	-	-	-	-	-	-	-
		L/60	-	-	-	-	-	-	-
	Double Span	ASD, W/Ω	218	163	113	83	64	50	40
		LRFD, φW	348	244	170	125	96	76	61
		L/180	-	-	-	-	-	-	-
		L/60	-	-	-	-	-	-	-
	Triple Span	ASD, W/Ω	247	198	141	103	79	63	51
LRFD, φW		396	303	212	155	119	95	77	
L/180		-	-	-	-	-	-	-	
L/60		-	-	-	-	-	-	-	

Table values denoted by "-" indicate that capacities are limited by panel strength not deflection.

**Clip/fastener attachment schedules (18" Design Span hp):**

**Tables 2.15 and 2.16 apply**



### 3.0 - Klip Rib

Figure 3.1 - Profile: As-installed view shown.

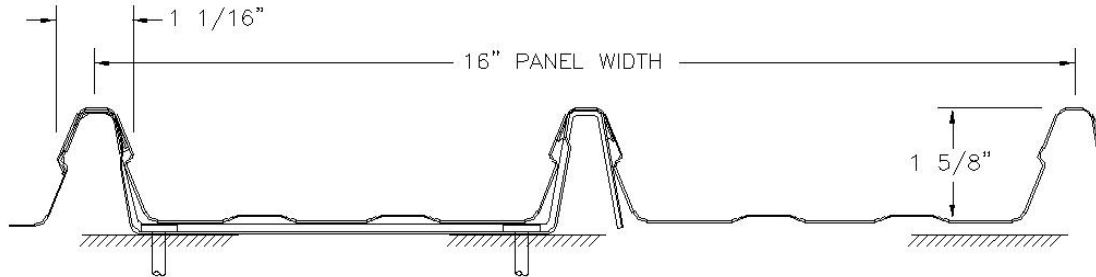

Table 3.1 - Profile:

<b>Panel Use:</b>	Roof (primary use), wall, fascia
<b>Substrates:</b>	Over spaced supports or solid substrate
<b>Available Gages:</b>	22, 24, 26 gage
<b>Minimum Slope:</b>	1:12 (8.33 %) [Slopes less than 2:12 requires field-applied mastic in seam]
<b>Load Combination Reduction Available (Ref. Section 5.6)</b>	Yes
<b>Uninstalled Panel View</b>	

Table 3.2 - Attachment:

<b>Clip Name:</b>	Klip Rib Clip
<b>Clip View:</b>	
<b>Clip Usage:</b>	Over spaced framing or solid substrates
<b>Part #:</b>	#KRCLP65 (KRCLP65MD, over rigid insulation)
<b>Panel/ Substrate Gap:</b>	3/16 inch
<b>Thermal Movement:</b>	Unlimited
<b>Fastener Limitations:</b>	Nom. size: #12 max (KRCLP65MD, 1/4 inch max.) Head height: 0.120 inch max. Head dia.: 1/2 inch max.
<b>Recommended Fastener(s):</b>	#10 or #12 pancake head
<b>Fastener Load Adjustment:</b>	N/A
<b>Associated Bearing Plate:</b>	N/A



**Table 3.3 - Section properties (Klip Rib):**

Gauge	Weight	Base Metal Thickness	Yield Strength	Tensile Strength	Gross Section Properties				
					Area	Moment of Inertia	Distance to N.A. from Bottom	Positive Section Modulus	Negative Section Modulus
	w psf	t in	Fy ksi	Fu ksi	A <sub>g</sub> in <sup>2</sup> /ft	I <sub>g</sub> in <sup>4</sup> /ft	y <sub>b</sub> in	S <sub>g</sub> <sup>+</sup> in <sup>3</sup> /ft	S <sub>g</sub> <sup>-</sup> in <sup>3</sup> /ft
26	1.11	0.0173	80	82	0.2975	0.0945	0.43	0.0792	0.2183
24	1.39	0.0232	50	65	0.3969	0.1245	0.43	0.1041	0.2875
22	1.75	0.0294	50	65	0.5010	0.1545	0.43	0.1298	0.3581

Gauge	Effective Section Properties							Uniform Load Only	
	Area	Positive			Negative			I <sub>d</sub> = (2I <sub>e</sub> +I <sub>g</sub> )/3  I <sub>+</sub> I <sub>-</sub>	
		Moment of Inertia	Distance to N.A. from Bottom	Section Modulus	Moment of Inertia	Distance to N.A. from Bottom	Section Modulus		
A <sub>e</sub> /ft in <sup>2</sup>	I <sub>e</sub> <sup>+</sup> in <sup>4</sup> /ft	y <sub>b</sub> in	S <sub>e</sub> <sup>+</sup> in <sup>3</sup> /ft	I <sub>e</sub> <sup>-</sup> in <sup>4</sup> /ft	y <sub>b</sub> in	S <sub>e</sub> <sup>-</sup> in <sup>3</sup> /ft	I <sub>+</sub> in <sup>4</sup> /ft	I <sub>-</sub> in <sup>4</sup> /ft	
26	0.1184	0.0930	0.43	0.0772	0.0530	0.78	0.0625	0.0935	0.0668
24	0.1832	0.1238	0.43	0.1037	0.0765	0.74	0.0857	0.1240	0.0925
22	0.2440	0.1545	0.43	0.1298	0.1005	0.71	0.1097	0.1545	0.1185

**Table 3.4 - Allowable reactions at supports (Klip Rib):**

Gauge	Condition	Allowable (lbs/ft width)	Factored (lbs/ft width)
26	1- End	348	557
	2- Interior	763	1222
24	1- End	480	769
	2- Interior	857	1371
22	1- End	704	1127
	2- Interior	1172	1876

Reaction capacities based on a minimum 1.5" web bearing length



**Table 3.5 - Positive (inward) uniform load design values (Klip Rib):**

Gauge	Span	Condition	Positive (Inward) Uniform Load Capacity (lbs/ft <sup>2</sup> ) / Span (ft - in.)						
			2' - 0"	2' - 6"	3' - 0"	3' - 6"	4' - 0"	4' - 6"	5' - 0"
26	Single Span	ASD, W/Ω	348	278	205	151	116	91	74
		LRFD, φW	557	446	326	239	183	145	117
		L/180	-	-	-	-	-	90	65
		L/60	-	-	-	-	-	-	-
	Double Span	ASD, W/Ω	305	232	163	120	92	72	59
		LRFD, φW	489	349	245	181	139	109	89
		L/180	-	-	-	-	-	-	-
		L/60	-	-	-	-	-	-	-
	Triple Span	ASD, W/Ω	347	277	201	149	114	90	74
LRFD, φW		555	432	303	224	172	136	111	
L/180		-	-	-	-	-	-	-	
L/60		-	-	-	-	-	-	-	
24	Single Span	ASD, W/Ω	480	331	230	169	129	102	83
		LRFD, φW	769	525	365	268	205	162	131
		L/180	-	-	-	-	-	-	-
		L/60	-	-	-	-	-	-	-
	Double Span	ASD, W/Ω	343	265	185	137	106	83	67
		LRFD, φW	549	399	279	206	159	125	101
		L/180	-	-	-	-	-	-	-
		L/60	-	-	-	-	-	-	-
	Triple Span	ASD, W/Ω	389	311	230	170	130	104	84
LRFD, φW		623	492	346	256	197	156	127	
L/180		-	-	-	-	-	-	-	
L/60		-	-	-	-	-	-	-	
22	Single Span	ASD, W/Ω	648	415	288	212	162	128	104
		LRFD, φW	1028	658	457	336	257	203	164
		L/180	-	-	-	-	-	-	-
		L/60	-	-	-	-	-	-	-
	Double Span	ASD, W/Ω	469	339	237	175	134	107	86
		LRFD, φW	751	509	357	263	202	160	130
		L/180	-	-	-	-	-	-	-
		L/60	-	-	-	-	-	-	-
	Triple Span	ASD, W/Ω	533	417	293	217	168	133	107
LRFD, φW		853	628	442	327	252	200	162	
L/180		-	-	-	-	-	-	-	
L/60		-	-	-	-	-	-	-	

Table values denoted by "-" indicate that capacities are limited by panel strength not deflection.



**Table 3.6 - Clip/fastener attachment schedule (No. 22 gage Klip Rib):**

Substrate		Fastener		Attachment Spacing, (ft-in)																	
		# per clip	Size	1' - 0"		1' - 6"		2' - 0"		2' - 6"		3' - 0"		3' - 6"		4' - 0"		4' - 6"		5' - 0"	
				Panel / Clip Negative (Outward) Uniform Load Capacity, (lbs/ft <sup>2</sup> )																	
				181	290	157	251	135	216	116	185	99	158	84	134	72	115	62	99	54	87
				Panel System Negative (Outward) Uniform Load Capacity, (lbs/ft <sup>2</sup> )																	
				ASD	LRFD	ASD	LRFD	ASD	LRFD	ASD	LRFD	ASD	LRFD	ASD	LRFD	ASD	LRFD	ASD	LRFD	ASD	LRFD
				W/Ω	φW	W/Ω	φW	W/Ω	φW	W/Ω	φW	W/Ω	φW	W/Ω	φW	W/Ω	φW	W/Ω	φW	W/Ω	φW
Cold Formed Steel (Gr 55 min.)	12ga (.1050")	2	#10	181	290	157	251	135	216	116	185	99	158	84	134	72	115	62	99	54	87
		2	#12	181	290	157	251	135	216	116	185	99	158	84	134	72	115	62	99	54	87
	14ga (.0700")	2	#10	181	290	157	251	135	216	116	185	99	158	84	134	72	115	62	99	54	87
		2	#12	181	290	157	251	135	216	116	185	99	158	84	134	72	115	62	99	54	87
	16ga (.0590")	2	#10	181	290	157	251	135	216	116	185	99	158	84	134	72	115	62	99	54	87
		2	#12	181	290	157	251	135	216	116	185	99	158	84	134	72	115	62	99	54	87
Cold Formed Steel (Gr 33 min.)	16ga (.0598")	2	#10	181	290	145	217	109	163	87	130	72	109	62	93	54	81	48	72	43	65
		2	#12	181	290	157	247	124	185	99	148	82	124	71	106	62	93	55	82	49	74
	18ga (.0478")	2	#10	174	261	116	174	87	131	69	104	58	87	50	75	43	65	39	58	35	52
		2	#12	181	290	132	197	99	148	79	118	66	99	56	84	49	74	44	66	39	59
	20ga (.0359")	2	#10	130	195	87	130	65	98	52	78	43	65	37	56	33	49	29	43	26	39
		2	#12	148	222	99	148	74	111	59	89	49	74	42	63	37	56	33	49	30	44
Plywood & OSB	15/32"	2	#10	123	167	82	111	62	83	49	67	41	56	35	48	31	42	27	37	25	33
		2	#12	140	189	93	126	70	95	56	76	47	63	40	54	35	47	31	42	28	38
	19/32"	2	#10	156	212	104	141	78	106	63	85	52	71	45	60	39	53	35	47	31	42
		2	#12	178	240	118	160	89	120	71	96	59	80	51	69	44	60	39	53	36	48
	23/32"	2	#10	181	255	126	170	95	128	76	102	63	85	54	73	47	64	42	57	38	51
		2	#12	181	290	143	194	108	146	86	116	72	97	61	83	54	73	48	65	43	58
Lumber (DFL)	1" min	2	#10	181	290	157	251	135	211	116	169	99	141	84	120	72	105	62	94	54	84
		2	#12	181	290	157	251	135	216	116	185	99	158	84	134	72	115	62	99	54	87

Specific Notes (Refer to the General Notes section for other applicable notes):

1. Number of clip fasteners can be increased to (4) or (6), and stated capacity doubled or tripled respectively, with the final capacity not to exceed the max Panel/Clip Capacity stated at the top of the chart.



**Table 3.7 - Clip/fastener attachment schedule (No. 24 gage Klip Rib):**

Substrate		Fastener		Attachment Spacing, (ft-in)																	
		# per clip	Size	1' - 0"		1' - 6"		2' - 0"		2' - 6"		3' - 0"		3' - 6"		4' - 0"		4' - 6"		5' - 0"	
				Panel / Clip Negative (Outward) Uniform Load Capacity, (lbs/ft <sup>2</sup> )																	
				98	156	88	140	78	125	69	111	61	98	54	86	48	76	42	67	37	59
Panel System Negative (Outward) Uniform Load Capacity, (lbs/ft <sup>2</sup> )																					
				ASD	LRFD	ASD	LRFD	ASD	LRFD	ASD	LRFD	ASD	LRFD	ASD	LRFD	ASD	LRFD	ASD	LRFD		
				W/Ω	φW	W/Ω	φW	W/Ω	φW	W/Ω	φW	W/Ω	φW	W/Ω	φW	W/Ω	φW	W/Ω	φW		
Cold Formed Steel (Gr 55 min.)	12ga (.1050")	2	#10	98	156	88	140	78	125	69	111	61	98	54	86	48	76	42	67	37	59
		2	#12	98	156	88	140	78	125	69	111	61	98	54	86	48	76	42	67	37	59
	14ga (.0700")	2	#10	98	156	88	140	78	125	69	111	61	98	54	86	48	76	42	67	37	59
		2	#12	98	156	88	140	78	125	69	111	61	98	54	86	48	76	42	67	37	59
	16ga (.0590")	2	#10	98	156	88	140	78	125	69	111	61	98	54	86	48	76	42	67	37	59
		2	#12	98	156	88	140	78	125	69	111	61	98	54	86	48	76	42	67	37	59
18ga (.0470")	2	#10	98	156	88	140	78	125	69	111	61	98	54	86	48	76	42	67	37	59	
	2	#12	98	156	88	140	78	125	69	111	61	98	54	86	48	76	42	67	37	59	
Cold Formed Steel (Gr 33 min.)	16ga (.0598")	2	#10	98	156	88	140	78	125	69	111	61	98	54	86	48	76	42	67	37	59
		2	#12	98	156	88	140	78	125	69	111	61	98	54	86	48	76	42	67	37	59
	18ga (.0478")	2	#10	98	156	88	140	78	125	69	104	58	87	50	75	43	65	39	58	35	52
		2	#12	98	156	88	140	78	125	69	111	61	98	54	84	48	74	42	66	37	59
	20ga (.0359")	2	#10	98	156	87	130	65	98	52	78	43	65	37	56	33	49	29	43	26	39
		2	#12	98	156	88	140	74	111	59	89	49	74	42	63	37	56	33	49	30	44
22ga (.0299")	2	#10	98	156	72	109	54	82	43	65	36	55	31	47	27	41	24	36	22	33	
	2	#12	98	156	82	124	62	93	49	74	41	62	35	53	31	47	27	41	25	37	
Plywood & OSB	15/32"	2	#10	98	156	82	111	62	83	49	67	41	56	35	48	31	42	27	37	25	33
		2	#12	98	156	88	126	70	95	56	76	47	63	40	54	35	47	31	42	28	38
	19/32"	2	#10	98	156	88	140	78	106	63	85	52	71	45	60	39	53	35	47	31	42
		2	#12	98	156	88	140	78	120	69	96	59	80	51	69	44	60	39	53	36	48
	23/32"	2	#10	98	156	88	140	78	125	69	102	61	85	54	73	47	64	42	57	37	51
		2	#12	98	156	88	140	78	125	69	111	61	97	54	83	48	73	42	65	37	58
Lumber (DFL)	1" min	2	#10	98	156	88	140	78	125	69	111	61	98	54	86	48	76	42	67	37	59
		2	#12	98	156	88	140	78	125	69	111	61	98	54	86	48	76	42	67	37	59

**Specific Notes (Refer to the General Notes section for other applicable notes):**

1. Number of clip fasteners can be increased to (4) or (6), and stated capacity doubled or tripled respectively, with the final capacity not to exceed the max Panel/Clip Capacity stated at the top of the chart.



**Table 3.8 - Clip/fastener attachment schedule (No. 26 gage Klip Rib):**

Substrate		Fastener		Attachment Spacing, (ft-in)																	
		# per clip	Size	1' - 0"		1' - 6"		2' - 0"		2' - 6"		3' - 0"		3' - 6"		4' - 0"		4' - 6"		5' - 0"	
				Panel / Clip Negative (Outward) Uniform Load Capacity, (lbs/ft <sup>2</sup> )																	
				58	92	49	79	42	68	36	58	32	50	28	45	26	41	24	39	24	39
Panel System Negative (Outward) Uniform Load Capacity, (lbs/ft <sup>2</sup> )																					
				ASD	LRFD	ASD	LRFD	ASD	LRFD	ASD	LRFD	ASD	LRFD	ASD	LRFD	ASD	LRFD	ASD	LRFD		
				W/Ω	φW	W/Ω	φW	W/Ω	φW	W/Ω	φW	W/Ω	φW	W/Ω	φW	W/Ω	φW	W/Ω	φW		
Cold Formed Steel (Gr 55 min.)	12ga (.1050")	2	#10	58	92	49	79	42	68	36	58	32	50	28	45	26	41	24	39	24	39
		2	#12	58	92	49	79	42	68	36	58	32	50	28	45	26	41	24	39	24	39
	14ga (.0700")	2	#10	58	92	49	79	42	68	36	58	32	50	28	45	26	41	24	39	24	39
		2	#12	58	92	49	79	42	68	36	58	32	50	28	45	26	41	24	39	24	39
	16ga (.0590")	2	#10	58	92	49	79	42	68	36	58	32	50	28	45	26	41	24	39	24	39
		2	#12	58	92	49	79	42	68	36	58	32	50	28	45	26	41	24	39	24	39
Cold Formed Steel (Gr 33 min.)	16ga (.0598")	2	#10	58	92	49	79	42	68	36	58	32	50	28	45	26	41	24	39	24	39
		2	#12	58	92	49	79	42	68	36	58	32	50	28	45	26	41	24	39	24	39
	18ga (.0478")	2	#10	58	92	49	79	42	68	36	58	32	50	28	45	26	41	24	39	24	39
		2	#12	58	92	49	79	42	68	36	58	32	50	28	45	26	41	24	39	24	39
	20ga (.0359")	2	#10	58	92	49	79	42	68	36	58	32	50	28	45	26	41	24	39	24	39
		2	#12	58	92	49	79	42	68	36	58	32	50	28	45	26	41	24	39	24	39
Plywood & OSB	15/32"	2	#10	58	92	49	79	42	68	36	58	32	50	28	45	26	41	24	37	24	33
		2	#12	58	92	49	79	42	68	36	58	32	50	28	45	26	41	24	39	24	38
	19/32"	2	#10	58	92	49	79	42	68	36	58	32	50	28	45	26	41	24	39	24	39
		2	#12	58	92	49	79	42	68	36	58	32	50	28	45	26	41	24	39	24	39
	23/32"	2	#10	58	92	49	79	42	68	36	58	32	50	28	45	26	41	24	39	24	39
		2	#12	58	92	49	79	42	68	36	58	32	50	28	45	26	41	24	39	24	39
Lumber (DFL)	1" min	2	#10	58	92	49	79	42	68	36	58	32	50	28	45	26	41	24	39	24	39
		2	#12	58	92	49	79	42	68	36	58	32	50	28	45	26	41	24	39	24	39

**Specific Notes (Refer to the General Notes section for other applicable notes):**

- Number of clip fasteners can be increased to (4) or (6), and stated capacity doubled or tripled respectively, with the final capacity not to exceed the max Panel/Clip Capacity stated at the top of the chart.

## 4.0 - Select Seam (Narrow Batten)

Figure 4.1 - Profile: As-installed view shown

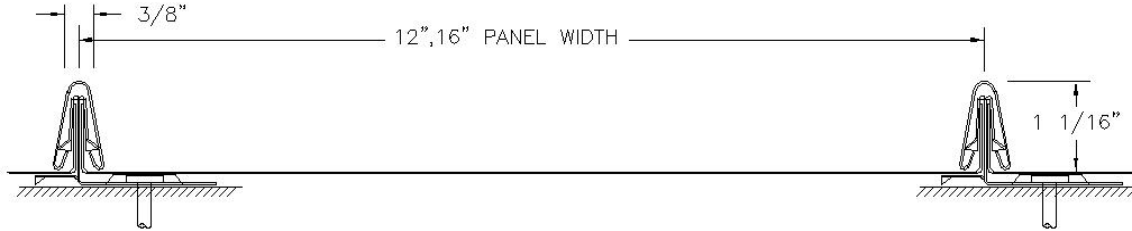

Table 4.1 - Profile:

<b>Panel Use:</b>	Roof (primary use), fascia
<b>Substrates:</b>	Over solid or closely fitted deck
<b>Available Gages:</b>	No. 22, 24 gage
<b>Minimum Slope:</b>	3:12 (25 percent)
<b>Load Combination Reduction Available (Ref. Section 5.6)</b>	Yes
<b>Uninstalled Panel View</b>	

Table 4.2 - Attachment:

<b>Clip Name:</b>	Narrow Batten Clip
<b>Clip View:</b>	
<b>Clip Usage:</b>	Over solid substrates only.
<b>Part #:</b>	#SSMCLPNBZA
<b>Panel/ Substrate Gap:</b>	3/16 inch
<b>Thermal Movement:</b>	Unlimited
<b>Fastener Limitations:</b>	Nom. size: 1/4 inch max. Head height: 0.140 inch max. Head dia.: 1 inch max.
<b>Recommended Fastener(s):</b>	#10 or #12 pancake head
<b>Fastener Load Adjustments (due to eccentricity of fasteners relative to panel seam):</b>	Per fastener: 1.61 $\Sigma M = 0$ 1.58P = .98R
<b>Associated Bearing Plate:</b>	#BPUNI22





**Table 4.3 - Section properties (12" Select Seam):**

Gauge	Weight	Base Metal Thickness	Yield Strength	Tensile Strength	Gross Section Properties				
					Area	Moment of Inertia	Distance to N.A. from Bottom	Positive Section Modulus	Negative Section Modulus
	w	t	Fy	Fu	A <sub>g</sub>	I <sub>g</sub>	y <sub>b</sub>	S <sub>g+</sub>	S <sub>g-</sub>
	psf	in	ksi	ksi	in <sup>2</sup> /ft	in <sup>4</sup> /ft	in	in <sup>3</sup> /ft	in <sup>3</sup> /ft
24	1.49	0.0232	50	65	0.3107	0.0057	0.05	0.0082	0.1093
22	1.86	0.0294	50	65	0.3932	0.0072	0.06	0.0103	0.1300

Gauge	Effective Section Properties							Uniform Load Only	
	Area	Positive			Negative			I <sub>d</sub> = (2I <sub>e</sub> +I <sub>g</sub> )/3	
		Moment of Inertia	Distance to N.A. from Bottom	Section Modulus	Moment of Inertia	Distance to N.A. from Bottom	Section Modulus		
A <sub>e</sub> /ft	I <sub>e+</sub>	y <sub>b</sub>	S <sub>e+</sub>	I <sub>e-</sub>	y <sub>b</sub>	S <sub>e-</sub>	I <sub>+</sub>	I <sub>-</sub>	
in <sup>2</sup>	in <sup>4</sup> /ft	in	in <sup>3</sup> /ft	in <sup>4</sup> /ft	in	in <sup>3</sup> /ft	in <sup>4</sup> /ft	in <sup>4</sup> /ft	
24	0.0442	0.0011	0.03	0.0015	0.0043	0.16	0.0073	0.0026	0.0048
22	0.0683	0.0023	0.03	0.0032	0.0059	0.14	0.0096	0.0039	0.0063

**Positive (inward) uniform load design values (12" Select Seam):**

**Design Values are not available. Select Seam requires installation over solid substrate.**



**Table 4.4 - Clip/fastener attachment schedule (12", No. 22 gage Select Seam):**

Substrate		Fastener		Attachment Spacing, (ft-in)																						
		# per clip	Size	1' - 0"	1' - 6"	2' - 0"	2' - 6"	3' - 0"	3' - 6"	4' - 0"	4' - 6"	5' - 0"														
				Panel / Clip Negative (Outward) Uniform Load Capacity, (lbs/ft <sup>2</sup> )																						
				132	209	105	166	77	122	69	109	61	96	52	83	44	70	36	56	27	43					
Panel System Negative (Outward) Uniform Load Capacity, (lbs/ft <sup>2</sup> )																										
				ASD	LRFD	ASD	LRFD	ASD	LRFD	ASD	LRFD	ASD	LRFD	ASD	LRFD	ASD	LRFD	ASD	LRFD							
				W/Ω	φW	W/Ω	φW	W/Ω	φW	W/Ω	φW	W/Ω	φW	W/Ω	φW	W/Ω	φW	W/Ω	φW							
Cold Formed Steel (Gr 55 min.)	12ga (.1050")	1	#10	132	209	105	166	77	122	69	109	61	96	52	83	44	70	36	56	27	43					
		1	#12	132	209	105	166	77	122	69	109	61	96	52	83	44	70	36	56	27	43					
	14ga (.0700")	1	#10	132	209	105	164	77	122	66	98	55	82	47	70	41	61	36	55	27	43					
		1	#12	132	209	105	166	77	122	69	109	61	93	52	80	44	70	36	56	27	43					
	16ga (.0590")	1	#10	132	207	92	138	69	103	55	83	46	69	39	59	35	52	31	46	27	41					
		1	#12	132	209	105	157	77	118	63	94	52	78	45	67	39	59	35	52	27	43					
Cold Formed Steel (Gr 33 min.)	18ga (.0470")	1	#10	110	165	73	110	55	83	44	66	37	55	31	47	28	41	24	37	22	33					
		1	#12	125	188	83	125	63	94	50	75	42	63	36	54	31	47	28	42	25	38					
	16ga (.0598")	1	#10	90	135	60	90	45	67	36	54	30	45	26	39	22	34	20	30	18	27					
		1	#12	102	153	68	102	51	77	41	61	34	51	29	44	26	38	23	34	20	31					
	18ga (.0478")	1	#10	72	108	48	72	36	54	29	43	24	36	21	31	18	27	16	24	14	22					
		1	#12	82	122	55	82	41	61	33	49	27	41	23	35	20	31	18	27	16	24					
Plywood & OSB	15/32"	1	#10	51	69	34	46	26	34	20	28	17	23	15	20	13	17	11	15	10	14					
		1	#12	58	78	39	52	29	39	23	31	19	26	17	22	15	20	13	17	12	16					
	19/32"	1	#10	65	88	43	58	32	44	26	35	22	29	18	25	16	22	14	19	13	18					
		1	#12	74	99	49	66	37	50	29	40	25	33	21	28	18	25	16	22	15	20					
Lumber (DFL)	1" min	1	#10	129	175	86	116	65	87	52	70	43	58	37	50	32	44	29	39	26	35					
		1	#12	132	198	98	132	73	99	59	79	49	66	42	57	37	50	33	44	27	40					

**Specific Notes (Refer to the General Notes section for other applicable notes):**

1. Table accounts for increased loads on fasteners due to the eccentricity of the fasteners relative to the panel seam. The Select Seam Narrow Batten panel summary chart at the front of this section provides for development of these fastener load adjustments.



**Table 4.5 - Clip/fastener attachment schedule (12", No. 24 gage Select Seam):**

Substrate		Fastener		Attachment Spacing, (ft-in)																	
				1' - 0"		1' - 6"		2' - 0"		2' - 6"		3' - 0"		3' - 6"		4' - 0"		4' - 6"		5' - 0"	
				Panel / Clip Negative (Outward) Uniform Load Capacity, (lbs/ft <sup>2</sup> )																	
				95	149	78	122	61	95	54	85	48	75	41	65	35	55	28	44	22	34
Panel System Negative (Outward) Uniform Load Capacity, (lbs/ft <sup>2</sup> )																					
				ASD	LRFD	ASD	LRFD	ASD	LRFD	ASD	LRFD	ASD	LRFD	ASD	LRFD	ASD	LRFD	ASD	LRFD		
				W/Ω	φW	W/Ω	φW	W/Ω	φW	W/Ω	φW	W/Ω	φW	W/Ω	φW	W/Ω	φW	W/Ω	φW		
Cold Formed Steel (Gr 55 min.)	12ga (.1050")	1	#10	95	149	78	122	61	95	54	85	48	75	41	65	35	55	28	44	22	34
		1	#12	95	149	78	122	61	95	54	85	48	75	41	65	35	55	28	44	22	34
	14ga (.0700")	1	#10	95	149	78	122	61	95	54	85	48	75	41	65	35	55	28	44	22	34
		1	#12	95	149	78	122	61	95	54	85	48	75	41	65	35	55	28	44	22	34
	16ga (.0590")	1	#10	95	149	78	122	61	95	54	83	46	69	39	59	35	52	28	44	22	34
		1	#12	95	149	78	122	61	95	54	85	48	75	41	65	35	55	28	44	22	34
	18ga (.0470")	1	#10	95	149	73	110	55	83	44	66	37	55	31	47	28	41	24	37	22	33
		1	#12	95	149	78	122	61	94	50	75	42	63	36	54	31	47	28	42	22	34
Cold Formed Steel (Gr 33 min.)	16ga (.0598")	1	#10	90	135	60	90	45	67	36	54	30	45	26	39	22	34	20	30	18	27
		1	#12	95	149	68	102	51	77	41	61	34	51	29	44	26	38	23	34	20	31
	18ga (.0478")	1	#10	72	108	48	72	36	54	29	43	24	36	21	31	18	27	16	24	14	22
		1	#12	82	122	55	82	41	61	33	49	27	41	23	35	20	31	18	27	16	24
	20ga (.0359")	1	#10	54	81	36	54	27	40	22	32	18	27	15	23	14	20	12	18	11	16
		1	#12	61	92	41	61	31	46	25	37	20	31	18	26	15	23	14	20	12	18
22ga (.0299")	1	#10	45	68	30	45	22	34	18	27	15	23	13	19	11	17	10	15	9	14	
	1	#12	51	77	34	51	26	39	20	31	17	26	15	22	13	19	11	17	10	15	
Plywood & OSB	15/32"	1	#10	51	69	34	46	26	34	20	28	17	23	15	20	13	17	11	15	10	14
		1	#12	58	78	39	52	29	39	23	31	19	26	17	22	15	20	13	17	12	16
	19/32"	1	#10	65	88	43	58	32	44	26	35	22	29	18	25	16	22	14	19	13	18
		1	#12	74	99	49	66	37	50	29	40	25	33	21	28	18	25	16	22	15	20
23/32"	1	#10	78	106	52	70	39	53	31	42	26	35	22	30	20	26	17	23	16	21	
	1	#12	89	120	59	80	45	60	36	48	30	40	25	34	22	30	20	27	18	24	
Lumber (DFL)	1" min	1	#10	95	149	78	116	61	87	52	70	43	58	37	50	32	44	28	39	22	34
		1	#12	95	149	78	122	61	95	54	79	48	66	41	57	35	50	28	44	22	34

Specific Notes (Refer to the General Notes section for other applicable notes):

1. Table accounts for increased loads on fasteners due to the eccentricity of the fasteners relative to the panel seam. The Select Seam Narrow Batten panel summary chart at the front of this section provides for development of these fastener load adjustments.



**Table 4.6 - Section properties (16" Select Seam):**

Gauge	Weight	Base Metal Thickness	Yield Strength	Tensile Strength	Gross Section Properties				
					Area	Moment of Inertia	Distance to N.A. from Bottom	Positive Section Modulus	Negative Section Modulus
	w	t	Fy	Fu	A <sub>g</sub>	I <sub>g</sub>	y <sub>b</sub>	S <sub>g</sub> <sup>+</sup>	S <sub>g</sub> <sup>-</sup>
	psf	in	ksi	ksi	in <sup>2</sup> /ft	in <sup>4</sup> /ft	in	in <sup>3</sup> /ft	in <sup>3</sup> /ft
24	1.36	0.0232	50	65	0.3026	0.0044	0.04	0.0062	0.1020
22	1.71	0.0294	50	65	0.3831	0.0053	0.05	0.0078	0.1199

Gauge	Effective Section Properties							Uniform Load Only	
	Area	Positive			Negative			I <sub>d</sub> = (2I <sub>e</sub> +I <sub>g</sub> )/3	
		Moment of Inertia	Distance to N.A. from Bottom	Section Modulus	Moment of Inertia	Distance to N.A. from Bottom	Section Modulus		
A <sub>e</sub> /ft	I <sub>e</sub> <sup>+</sup>	y <sub>b</sub>	S <sub>e</sub> <sup>+</sup>	I <sub>e</sub> <sup>-</sup>	y <sub>b</sub>	S <sub>e</sub> <sup>-</sup>	I <sub>d</sub> <sup>+</sup>	I <sub>d</sub> <sup>-</sup>	
in <sup>2</sup>	in <sup>4</sup> /ft	in	in <sup>3</sup> /ft	in <sup>4</sup> /ft	in	in <sup>3</sup> /ft	in <sup>4</sup> /ft	in <sup>4</sup> /ft	
24	0.0332	0.0008	0.02	0.0011	0.0032	0.16	0.0055	0.0020	0.0036
22	0.0514	0.0017	0.03	0.0024	0.0044	0.14	0.0072	0.0029	0.0047

**Positive (inward) uniform load design values (16" Select Seam):**

**Design Values are not available. Select Seam requires installation over solid substrate.**



**Table 4.7 - Clip/fastener attachment schedule (16", No. 22 gage Select Seam):**

Substrate		Fastener		Attachment Spacing, (ft-in)																	
		# per clip	Size	1' - 0"		1' - 6"		2' - 0"		2' - 6"		3' - 0"		3' - 6"		4' - 0"		4' - 6"		5' - 0"	
				Panel / Clip Negative (Outward) Uniform Load Capacity, (lbs/ft <sup>2</sup> )																	
				97	153	81	128	65	104	58	92	50	80	43	68	35	56	28	44	21	32
Panel System Negative (Outward) Uniform Load Capacity, (lbs/ft <sup>2</sup> )																					
				ASD	LRFD	ASD	LRFD	ASD	LRFD	ASD	LRFD	ASD	LRFD	ASD	LRFD	ASD	LRFD	ASD	LRFD	ASD	LRFD
				W/Ω	φW	W/Ω	φW	W/Ω	φW	W/Ω	φW	W/Ω	φW	W/Ω	φW	W/Ω	φW	W/Ω	φW	W/Ω	φW
Cold Formed Steel (Gr 55 min.)	12ga (.1050")	1	#10	97	153	81	128	65	104	58	92	50	80	43	68	35	56	28	44	21	32
		1	#12	97	153	81	128	65	104	58	92	50	80	43	68	35	56	28	44	21	32
	14ga (.0700")	1	#10	97	153	81	123	61	92	49	74	41	61	35	53	31	46	27	41	21	32
		1	#12	97	153	81	128	65	104	56	84	47	70	40	60	35	52	28	44	21	32
	16ga (.0590")	1	#10	97	153	69	103	52	78	41	62	35	52	30	44	26	39	23	34	21	31
		1	#12	97	153	78	118	59	88	47	71	39	59	34	50	29	44	26	39	21	32
18ga (.0470")	1	#10	83	124	55	83	41	62	33	50	28	41	24	35	21	31	18	28	17	25	
	1	#12	94	141	63	94	47	70	38	56	31	47	27	40	23	35	21	31	19	28	
Cold Formed Steel (Gr 33 min.)	16ga (.0598")	1	#10	67	101	45	67	34	51	27	40	22	34	19	29	17	25	15	22	13	20
		1	#12	77	115	51	77	38	58	31	46	26	38	22	33	19	29	17	26	15	23
	18ga (.0478")	1	#10	54	81	36	54	27	41	22	32	18	27	15	23	13	20	12	18	11	16
		1	#12	61	92	41	61	31	46	25	37	20	31	18	26	15	23	14	20	12	18
	20ga (.0359")	1	#10	41	61	27	40	20	30	16	24	14	20	12	17	10	15	9	13	8	12
		1	#12	46	69	31	46	23	34	18	28	15	23	13	20	12	17	10	15	9	14
22ga (.0299")	1	#10	34	51	22	34	17	25	13	20	11	17	10	15	8	13	7	11	7	10	
	1	#12	38	58	26	39	19	29	15	23	13	19	11	17	10	14	9	13	8	12	
Plywood & OSB	15/32"	1	#10	38	52	26	34	19	26	15	21	13	17	11	15	10	13	9	11	8	10
		1	#12	44	59	29	39	22	29	17	23	15	20	12	17	11	15	10	13	9	12
	19/32"	1	#10	49	66	32	44	24	33	19	26	16	22	14	19	12	16	11	15	10	13
		1	#12	55	75	37	50	28	37	22	30	18	25	16	21	14	19	12	17	11	15
	23/32"	1	#10	59	79	39	53	29	40	23	32	20	26	17	23	15	20	13	18	12	16
		1	#12	67	90	45	60	33	45	27	36	22	30	19	26	17	23	15	20	13	18
Lumber (DFL)	1" min	1	#10	97	131	65	87	48	65	39	52	32	44	28	37	24	33	22	29	19	26
		1	#12	97	149	73	99	55	74	44	59	37	50	31	42	28	37	24	33	21	30

Specific Notes (Refer to the General Notes section for other applicable notes):

1. Table accounts for increased loads on fasteners due to the eccentricity of the fasteners relative to the panel seam. The Select Seam Narrow Batten panel summary chart at the front of this section provides for development of these fastener load adjustments.



**Table 4.8 - Clip/fastener attachment schedule (16", No. 24 gage Select Seam):**

Substrate		Fastener		Attachment Spacing, (ft-in)																	
		# per clip	Size	1' - 0"		1' - 6"		2' - 0"		2' - 6"		3' - 0"		3' - 6"		4' - 0"		4' - 6"		5' - 0"	
				Panel / Clip Negative (Outward) Uniform Load Capacity, (lbs/ft <sup>2</sup> )																	
				70	112	55	88	40	65	36	58	32	51	28	45	24	38	19	31	15	24
Panel System Negative (Outward) Uniform Load Capacity, (lbs/ft <sup>2</sup> )																					
				ASD	LRFD	ASD	LRFD	ASD	LRFD	ASD	LRFD	ASD	LRFD	ASD	LRFD	ASD	LRFD	ASD	LRFD	ASD	LRFD
				W/Ω	φW	W/Ω	φW	W/Ω	φW	W/Ω	φW	W/Ω	φW	W/Ω	φW	W/Ω	φW	W/Ω	φW	W/Ω	φW
Cold Formed Steel (Gr 55 min.)	12ga (.1050")	1	#10	70	112	55	88	40	65	36	58	32	51	28	45	24	38	19	31	15	24
		1	#12	70	112	55	88	40	65	36	58	32	51	28	45	24	38	19	31	15	24
	14ga (.0700")	1	#10	70	112	55	88	40	65	36	58	32	51	28	45	24	38	19	31	15	24
		1	#12	70	112	55	88	40	65	36	58	32	51	28	45	24	38	19	31	15	24
	16ga (.0590")	1	#10	70	112	55	88	40	65	36	58	32	51	28	44	24	38	19	31	15	24
		1	#12	70	112	55	88	40	65	36	58	32	51	28	45	24	38	19	31	15	24
	18ga (.0470")	1	#10	70	112	55	83	40	62	33	50	28	41	24	35	21	31	18	28	15	24
		1	#12	70	112	55	88	40	65	36	56	31	47	27	40	23	35	19	31	15	24
Cold Formed Steel (Gr 33 min.)	16ga (.0598")	1	#10	67	101	45	67	34	51	27	40	22	34	19	29	17	25	15	22	13	20
		1	#12	70	112	51	77	38	58	31	46	26	38	22	33	19	29	17	26	15	23
	18ga (.0478")	1	#10	54	81	36	54	27	41	22	32	18	27	15	23	13	20	12	18	11	16
		1	#12	61	92	41	61	31	46	25	37	20	31	18	26	15	23	14	20	12	18
	20ga (.0359")	1	#10	41	61	27	40	20	30	16	24	14	20	12	17	10	15	9	13	8	12
		1	#12	46	69	31	46	23	34	18	28	15	23	13	20	12	17	10	15	9	14
	22ga (.0299")	1	#10	34	51	22	34	17	25	13	20	11	17	10	15	8	13	7	11	7	10
		1	#12	38	58	26	39	19	29	15	23	13	19	11	17	10	14	9	13	8	12
Plywood & OSB	15/32"	1	#10	38	52	26	34	19	26	15	21	13	17	11	15	10	13	9	11	8	10
		1	#12	44	59	29	39	22	29	17	23	15	20	12	17	11	15	10	13	9	12
	19/32"	1	#10	49	66	32	44	24	33	19	26	16	22	14	19	12	16	11	15	10	13
		1	#12	55	75	37	50	28	37	22	30	18	25	16	21	14	19	12	17	11	15
	23/32"	1	#10	59	79	39	53	29	40	23	32	20	26	17	23	15	20	13	18	12	16
		1	#12	67	90	45	60	33	45	27	36	22	30	19	26	17	23	15	20	13	18
Lumber (DFL)	1" min	1	#10	70	112	55	87	40	65	36	52	32	44	28	37	24	33	19	29	15	24
		1	#12	70	112	55	88	40	65	36	58	32	50	28	42	24	37	19	31	15	24

**Specific Notes (Refer to the General Notes section for other applicable notes):**

1. Table accounts for increased loads on fasteners due to the eccentricity of the fasteners relative to the panel seam. The Select Seam Narrow Batten panel summary chart at the front of this section provides for development of these fastener load adjustments.

## 5.0 - Prestige Series

Figure 5.1 - Profile: As installed view shown, with optional clip.

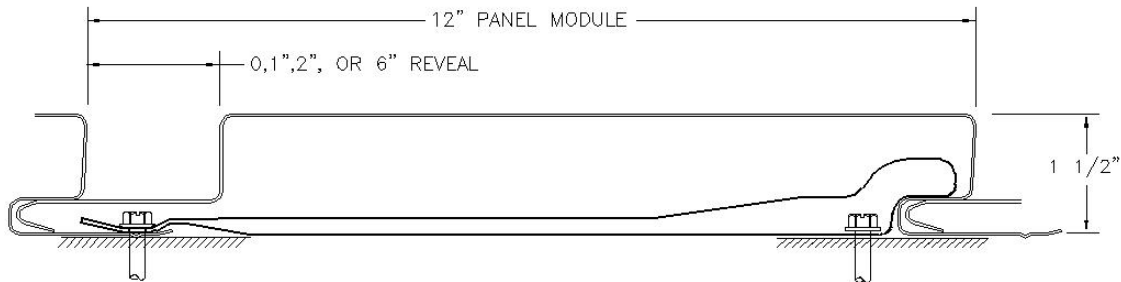

Table 5.1 - Profile:

<b>Panel Use:</b>	Wall, soffit, fascia, ceiling
<b>Substrates:</b>	Over solid substrate or over open framing
<b>Available Gages:</b>	Nos. 18, 20, 22, 24 gage
<b>Minimum Slope:</b>	Wall (installed horiz. or vertically) or soffit applications only
<b>Load Combination Reduction Available (Ref. Section 5.6)</b>	N/A
<b>Uninstalled Panel View</b>	

Table 5.2 - Attachment:

<b>Clip Name:</b>	Prestige Clip
<b>Clip View:</b>	
<b>Clip Usage:</b>	Optional, however most applications require clip to meet wind loads. Over spaced framing or solid substrates.
<b>Part #:</b>	#PS12CLP
<b>Panel/ Substrate Gap:</b>	0"
<b>Thermal Movement:</b>	None.
<b>Fastener Limitations:</b>	Nom. size: #14 max. Head height: 1/4 inch maximum Head dia.: 1/2 inch maximum
<b>Recommended Fastener(s):</b>	#10 or #12 pancake head #12 or 1/4 inch dia. hex washer head
<b>Fastener Load Adjustments (due to eccentricity of fasteners relative to panel seam):</b>	3 fasteners: 1.16 $\Sigma M = 0$ $11.29P = 9.33R_1 + 10.08R_2$
<b>Associated Bearing Plate:</b>	N/A



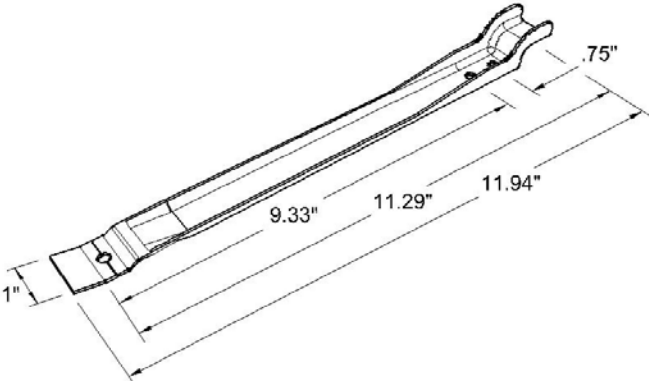

**Table 5.3 - Section properties (Full 12" Prestige Series):**

Gauge	Weight	Base Metal Thickness	Yield Strength	Tensile Strength	Gross Section Properties				
					Area	Moment of Inertia	Distance to N.A. from Bottom	Positive Section Modulus	Negative Section Modulus
	w psf	t in	Fy ksi	Fu ksi	A <sub>g</sub> in <sup>2</sup> /ft	I <sub>g</sub> in <sup>4</sup> /ft	y <sub>b</sub> in	S <sub>g+</sub> in <sup>3</sup> /ft	S <sub>g-</sub> in <sup>3</sup> /ft
24	1.51	0.0232	50	65	0.4295	0.1379	1.12	0.3536	0.1234
22	1.89	0.0294	50	65	0.5426	0.1710	1.11	0.4406	0.1540
20	2.27	0.0354	40	55	0.6517	0.2030	1.11	0.5222	0.1833
18	2.93	0.0459	40	55	0.8415	0.2550	1.10	0.6587	0.2329

Gauge	Effective Section Properties							Uniform Load Only	
	Area	Positive			Negative			I <sub>d</sub> = (2I <sub>e</sub> +I <sub>g</sub> )/3	
		Moment of Inertia	Distance to N.A. from Bottom	Section Modulus	Moment of Inertia	Distance to N.A. from Bottom	Section Modulus		
A <sub>e</sub> /ft in <sup>2</sup>	I <sub>e+</sub> in <sup>4</sup> /ft	y <sub>b</sub> in	S <sub>e+</sub> in <sup>3</sup> /ft	I <sub>e-</sub> in <sup>4</sup> /ft	y <sub>b</sub> in	S <sub>e-</sub> in <sup>3</sup> /ft	I <sub>+</sub> in <sup>4</sup> /ft	I <sub>-</sub> in <sup>4</sup> /ft	
24	0.1426	0.0546	0.61	0.0605	0.0882	1.22	0.0721	0.0824	0.1048
22	0.1944	0.0741	0.63	0.0853	0.1152	1.21	0.0954	0.1064	0.1338
20	0.2552	0.0990	0.68	0.1203	0.1450	1.19	0.1221	0.1337	0.1643
18	0.3584	0.1380	0.71	0.1799	0.1920	1.16	0.1649	0.1770	0.2130

**Table 5.4 - Allowable reactions at supports (Full 12" Prestige Series):**

Gauge	Condition	Allowable (lbs/ft width)	Factored (lbs/ft width)
24	1- End	468	749
	2- Interior	517	827
22	1- End	656	1051
	2- Interior	816	1307
20	1- End	656	1051
	2- Interior	816	1307
18	1- End	656	1051
	2- Interior	816	1307

Reaction capacities based on a minimum 1.5" web bearing length



Table 5.5 - Positive (inward) uniform load design values (Full 12" Reveal Prestige Series):

Gauge	Span	Condition	Positive (Inward) Uniform Load Capacity (lbs/ft <sup>2</sup> ) / Span (ft. - in.)						
			2' - 0"	3' - 0"	4' - 0"	5' - 0"	6' - 0"	7' - 0"	7' - 6"
24	Single Span	ASD, W/Ω	302	134	75	48	34	25	21
		LRFD, φW	479	213	120	77	53	39	34
		L/180	-	-	-	-	33	21	17
		L/60	-	-	-	-	-	-	-
	Double Span	ASD, W/Ω	207	138	87	56	39	28	25
		LRFD, φW	331	221	131	85	59	43	38
		L/180	-	-	-	-	-	-	-
		L/60	-	-	-	-	-	-	-
	Triple Span	ASD, W/Ω	235	157	108	70	49	35	31
LRFD, φW		376	251	162	105	74	54	47	
L/180		-	-	-	-	-	-	-	
22	Single Span	ASD, W/Ω	426	189	106	68	47	35	30
		LRFD, φW	675	300	169	108	75	55	48
		L/180	-	-	-	-	43	27	22
		L/60	-	-	-	-	-	-	-
	Double Span	ASD, W/Ω	326	200	115	74	52	38	34
		LRFD, φW	523	302	173	112	78	57	50
		L/180	-	-	-	-	-	-	-
		L/60	-	-	-	-	-	-	-
	Triple Span	ASD, W/Ω	371	246	143	92	64	48	41
LRFD, φW		594	370	214	139	97	72	62	
L/180		-	-	-	-	-	-	-	
20	Single Span	ASD, W/Ω	480	213	120	77	53	39	34
		LRFD, φW	762	339	190	122	85	62	54
		L/180	-	-	-	-	-	34	28
		L/60	-	-	-	-	-	-	-
	Double Span	ASD, W/Ω	326	204	118	76	53	39	34
		LRFD, φW	523	307	177	115	80	59	51
		L/180	-	-	-	-	-	-	-
		L/60	-	-	-	-	-	-	-
	Triple Span	ASD, W/Ω	371	247	144	94	65	48	42
LRFD, φW		594	375	218	142	99	73	64	
L/180		-	-	-	-	-	-	-	
18	Single Span	ASD, W/Ω	656	319	180	115	80	59	51
		LRFD, φW	1051	506	285	182	127	93	81
		L/180	-	-	-	-	72	45	37
		L/60	-	-	-	-	-	-	-
	Double Span	ASD, W/Ω	326	218	158	103	71	53	46
		LRFD, φW	523	348	238	154	107	80	69
		L/180	-	-	-	-	-	-	-
		L/60	-	-	-	-	-	-	-
	Triple Span	ASD, W/Ω	371	247	185	127	88	65	57
LRFD, φW		594	396	292	191	133	99	86	
L/180		-	-	-	-	-	-	-	
L/60	-	-	-	-	-	-	-		

Table values denoted by "-" indicate that capacities are limited by panel strength not deflection.



**Table 5.6 - Clip/fastener attachment schedule (No. 20 and 22 gage Prestige Series with 0" or 1" reveal, DIRECT FASTENED):**

Substrate		Fastener		Attachment Spacing, (ft-in)														
		#	Size	2' - 0"		3' - 0"		4' - 0"		5' - 0"		6' - 0"		7' - 0"		7' - 6"		
				Panel Negative (Outward) Uniform Load Capacity, (lbs/ft <sup>2</sup> )														
				20	29	19	29	19	28	19	28	18	28	18	27	18	27	
Panel System Negative (Outward) Uniform Load Capacity, (lbs/ft <sup>2</sup> )																		
				ASD	LRFD	ASD	LRFD	ASD	LRFD	ASD	LRFD	ASD	LRFD	ASD	LRFD	ASD	LRFD	
				W/Ω	φW	W/Ω	φW	W/Ω	φW	W/Ω	φW	W/Ω	φW	W/Ω	φW	W/Ω	φW	
Cold Formed Steel (Gr 55 min.)	12ga (.1050")	1	#10	20	29	19	29	19	28	19	28	18	28	18	27	18	27	
		1	#12	20	29	19	29	19	28	19	28	18	28	18	27	18	27	
		1	1/4"	20	29	19	29	19	28	19	28	18	28	18	27	18	27	
	14ga (.0700")	1	#10	20	29	19	29	19	28	19	28	18	28	18	27	18	27	
		1	#12	20	29	19	29	19	28	19	28	18	28	18	27	18	27	
		1	1/4"	20	29	19	29	19	28	19	28	18	28	18	27	18	27	
	16ga (.0590")	1	#10	20	29	19	29	19	28	19	28	18	28	18	27	18	27	
		1	#12	20	29	19	29	19	28	19	28	18	28	18	27	18	27	
		1	1/4"	20	29	19	29	19	28	19	28	18	28	18	27	18	27	
	18ga (.0470")	1	#10	20	29	19	29	19	28	19	28	18	28	18	27	18	27	
		1	#12	20	29	19	29	19	28	19	28	18	28	18	27	18	27	
		1	1/4"	20	29	19	29	19	28	19	28	18	28	18	27	18	27	
Cold Formed Steel (Gr 33 min.)	16ga (.0598")	1	#10	20	29	19	29	19	28	19	28	18	28	18	27	18	27	
		1	#12	20	29	19	29	19	28	19	28	18	28	18	27	18	27	
		1	1/4"	20	29	19	29	19	28	19	28	18	28	18	27	18	27	
	18ga (.0478")	1	#10	20	29	19	29	19	28	19	28	18	28	17	25	15	23	
		1	#12	20	29	19	29	19	28	19	28	18	28	18	27	18	26	
		1	1/4"	20	29	19	29	19	28	19	28	18	28	18	27	18	27	
	20ga (.0359")	1	#10	20	29	19	29	19	28	17	26	14	22	12	19	12	17	
		1	#12	20	29	19	29	19	28	19	28	16	25	14	21	13	20	
		1	1/4"	20	29	19	29	19	28	19	28	18	28	16	25	15	23	
	22ga (.0299")	1	#10	20	29	19	29	18	27	14	22	12	18	10	16	10	15	
		1	#12	20	29	19	29	19	28	16	25	14	21	12	18	11	17	
		1	1/4"	20	29	19	29	19	28	19	28	16	24	14	20	13	19	
Plywood & OSB	15/32"	1	#10	20	29	19	29	19	28	16	22	14	19	12	16	11	15	
		1	#12	20	29	19	29	19	28	19	25	16	21	13	18	12	17	
		1	#14	20	29	19	29	19	28	19	28	17	23	15	20	14	19	
	19/32"	1	#10	20	29	19	29	19	28	19	28	17	24	15	20	14	19	
		1	#12	20	29	19	29	19	28	19	28	18	27	17	23	16	21	
		1	#14	20	29	19	29	19	28	19	28	18	28	18	25	17	23	
	23/32"	1	#10	20	29	19	29	19	28	19	28	18	28	18	24	17	23	
		1	#12	20	29	19	29	19	28	19	28	18	28	18	27	18	26	
		1	#14	20	29	19	29	19	28	19	28	18	28	18	27	18	27	
	Lumber (DFL)	1" min	1	#10	20	29	19	29	19	28	19	28	18	28	18	27	18	27
			1	#12	20	29	19	29	19	28	19	28	18	28	18	27	18	27
			1	#14	20	29	19	29	19	28	19	28	18	28	18	27	18	27



**Table 5.7 - Clip/fastener attachment schedule (No. 24 gage Prestige Series with 0" or 1" reveal, DIRECT FASTENED):**

Substrate		Fastener		Attachment Spacing, (ft-in)													
		#	Size	2' - 0"	3' - 0"	4' - 0"	5' - 0"	6' - 0"	7' - 0"	7' - 6"							
				Panel Negative (Outward) Uniform Load Capacity, (lbs/ft <sup>2</sup> )													
				14	22	14	21	13	20	12	19	12	18	11	17	11	16
Panel System Negative (Outward) Uniform Load Capacity, (lbs/ft <sup>2</sup> )																	
				ASD	LRFD	ASD	LRFD	ASD	LRFD	ASD	LRFD	ASD	LRFD	ASD	LRFD		
				W/Ω	φW	W/Ω	φW	W/Ω	φW	W/Ω	φW	W/Ω	φW	W/Ω	φW		
Cold Formed Steel (Gr 55 min.)	12ga (.1050")	1	#10	14	22	14	21	13	20	12	19	12	18	11	17	11	16
		1	#12	14	22	14	21	13	20	12	19	12	18	11	17	11	16
		1	1/4"	14	22	14	21	13	20	12	19	12	18	11	17	11	16
	14ga (.0700")	1	#10	14	22	14	21	13	20	12	19	12	18	11	17	11	16
		1	#12	14	22	14	21	13	20	12	19	12	18	11	17	11	16
		1	1/4"	14	22	14	21	13	20	12	19	12	18	11	17	11	16
	16ga (.0590")	1	#10	14	22	14	21	13	20	12	19	12	18	11	17	11	16
		1	#12	14	22	14	21	13	20	12	19	12	18	11	17	11	16
		1	1/4"	14	22	14	21	13	20	12	19	12	18	11	17	11	16
	18ga (.0470")	1	#10	14	22	14	21	13	20	12	19	12	18	11	17	11	16
		1	#12	14	22	14	21	13	20	12	19	12	18	11	17	11	16
		1	1/4"	14	22	14	21	13	20	12	19	12	18	11	17	11	16
Cold Formed Steel (Gr 33 min.)	16ga (.0598")	1	#10	14	22	14	21	13	20	12	19	12	18	11	17	11	16
		1	#12	14	22	14	21	13	20	12	19	12	18	11	17	11	16
		1	1/4"	14	22	14	21	13	20	12	19	12	18	11	17	11	16
	18ga (.0478")	1	#10	14	22	14	21	13	20	12	19	12	18	11	17	11	16
		1	#12	14	22	14	21	13	20	12	19	12	18	11	17	11	16
		1	1/4"	14	22	14	21	13	20	12	19	12	18	11	17	11	16
	20ga (.0359")	1	#10	14	22	14	21	13	20	12	19	12	18	11	17	11	16
		1	#12	14	22	14	21	13	20	12	19	12	18	11	17	11	16
		1	1/4"	14	22	14	21	13	20	12	19	12	18	11	17	11	16
	22ga (.0299")	1	#10	14	22	14	21	13	20	12	19	12	18	10	16	10	15
		1	#12	14	22	14	21	13	20	12	19	12	18	11	17	11	16
		1	1/4"	14	22	14	21	13	20	12	19	12	18	11	17	11	16
Plywood & OSB	15/32"	1	#10	14	22	14	21	13	20	12	19	12	18	11	16	11	15
		1	#12	14	22	14	21	13	20	12	19	12	18	11	17	11	16
		1	#14	14	22	14	21	13	20	12	19	12	18	11	17	11	16
	19/32"	1	#10	14	22	14	21	13	20	12	19	12	18	11	17	11	16
		1	#12	14	22	14	21	13	20	12	19	12	18	11	17	11	16
		1	#14	14	22	14	21	13	20	12	19	12	18	11	17	11	16
	23/32"	1	#10	14	22	14	21	13	20	12	19	12	18	11	17	11	16
		1	#12	14	22	14	21	13	20	12	19	12	18	11	17	11	16
		1	#14	14	22	14	21	13	20	12	19	12	18	11	17	11	16
Lumber (DFL)	1" min	1	#10	14	22	14	21	13	20	12	19	12	18	11	17	11	16
		1	#12	14	22	14	21	13	20	12	19	12	18	11	17	11	16
		1	#14	14	22	14	21	13	20	12	19	12	18	11	17	11	16



**Table 5.8 - Clip/fastener attachment schedule (No. 20 and 22 gage Prestige Series with 0" or 1" reveal - CLIP ATTACHED):**

Substrate		Fastener		Attachment Spacing, (ft-in)													
		# per clip	Size	2' - 0"		3' - 0"		4' - 0"		5' - 0"		6' - 0"		7' - 0"		7' - 6"	
				Panel / Clip Negative (Outward) Uniform Load Capacity, (lbs/ft <sup>2</sup> )													
				88	142	88	142	76	122	64	102	51	82	39	62	33	53
Panel System Negative (Outward) Uniform Load Capacity, (lbs/ft <sup>2</sup> )																	
				ASD	LRFD	ASD	LRFD	ASD	LRFD	ASD	LRFD	ASD	LRFD	ASD	LRFD	ASD	LRFD
				W/Ω	φW	W/Ω	φW	W/Ω	φW	W/Ω	φW	W/Ω	φW	W/Ω	φW	W/Ω	φW
Cold Formed Steel (Gr 55 min.)	12ga (.1050")	3	#10	88	142	88	142	76	122	64	102	51	82	39	62	33	53
		3	#12	88	142	88	142	76	122	64	102	51	82	39	62	33	53
		3	1/4"	88	142	88	142	76	122	64	102	51	82	39	62	33	53
	14ga (.0700")	3	#10	88	142	88	142	76	122	64	102	51	82	39	62	33	53
		3	#12	88	142	88	142	76	122	64	102	51	82	39	62	33	53
		3	1/4"	88	142	88	142	76	122	64	102	51	82	39	62	33	53
	16ga (.0590")	3	#10	88	142	88	142	76	122	64	102	51	82	39	62	33	53
		3	#12	88	142	88	142	76	122	64	102	51	82	39	62	33	53
		3	1/4"	88	142	88	142	76	122	64	102	51	82	39	62	33	53
	18ga (.0470")	3	#10	88	142	88	142	76	115	61	92	51	76	39	62	33	53
		3	#12	88	142	88	142	76	122	64	102	51	82	39	62	33	53
		3	1/4"	88	142	88	142	76	122	64	102	51	82	39	62	33	53
Cold Formed Steel (Gr 33 min.)	16ga (.0598")	3	#10	88	142	83	125	62	94	50	75	42	62	36	53	33	50
		3	#12	88	142	88	142	71	106	57	85	47	71	39	61	33	53
		3	1/4"	88	142	88	142	76	122	64	99	51	82	39	62	33	53
	18ga (.0478")	3	#10	88	142	67	100	50	75	40	60	33	50	29	43	27	40
		3	#12	88	142	76	113	57	85	45	68	38	57	32	49	30	45
		3	1/4"	88	142	88	132	66	99	53	79	44	66	38	56	33	53
	20ga (.0359")	3	#10	75	112	50	75	37	56	30	45	25	37	21	32	20	30
		3	#12	85	128	57	85	43	64	34	51	28	43	24	36	23	34
		3	1/4"	88	142	66	99	49	74	39	59	33	49	28	42	26	40
	22ga (.0299")	3	#10	62	94	42	63	31	47	25	38	21	31	18	27	17	25
		3	#12	71	107	47	71	35	53	28	43	24	36	20	31	19	29
		3	1/4"	82	123	55	82	41	62	33	49	27	41	23	35	22	33
Plywood & OSB	15/32"	3	#10	71	96	47	64	35	48	28	38	24	32	20	27	19	26
		3	#12	81	109	54	72	40	54	32	43	27	36	23	31	21	29
		3	#14	88	120	59	80	44	60	36	48	30	40	25	34	24	32
	19/32"	3	#10	88	122	60	81	45	61	36	49	30	41	26	35	24	32
		3	#12	88	138	68	92	51	69	41	55	34	46	29	39	27	37
		3	#14	88	142	75	101	56	76	45	61	37	51	32	43	30	40
	23/32"	3	#10	88	142	72	98	54	73	43	59	36	49	31	42	29	39
		3	#12	88	142	82	111	62	84	49	67	41	56	35	48	33	45
		3	#14	88	142	88	122	68	92	54	73	45	61	39	52	33	49
Lumber (DFL)	1" min	3	#10	88	142	88	142	76	121	64	97	51	81	39	62	33	53
		3	#12	88	142	88	142	76	122	64	102	51	82	39	62	33	53
		3	#14	88	142	88	142	76	122	64	102	51	82	39	62	33	53

**Specific Notes (Refer to the General Notes section for other applicable notes):**

1. Table accounts for increased loads on fasteners due to the eccentricity of the fasteners relative to the panel seam. The Prestige Series panel summary chart at the front of this section provides for development of these fastener load adjustments.

2. Number of fasteners can be reduced to (2) if project load requirements can still be met. Reduce stated capacities above by 1/2 (the third fastener @ panel nailing flange does not factor into the above capacities).



**Table 5.9 - Clip/fastener attachment schedule (No. 24 gage Prestige Series with 0" or 1" reveal – CLIP ATTACHED):**

Substrate		Fastener		Attachment Spacing, (ft-in)																
		# per clip	Size	2' - 0"	3' - 0"	4' - 0"	5' - 0"	6' - 0"	7' - 0"	7' - 6"										
				Panel / Clip Negative (Outward) Uniform Load Capacity, (lbs/ft <sup>2</sup> )																
				69	110	69	110	61	98	53	85	45	72	37	59	33	53			
Panel System Negative (Outward) Uniform Load Capacity, (lbs/ft <sup>2</sup> )																				
				ASD	LRFD	ASD	LRFD	ASD	LRFD	ASD	LRFD	ASD	LRFD	ASD	LRFD					
				W/Ω	φW	W/Ω	φW	W/Ω	φW	W/Ω	φW	W/Ω	φW	W/Ω	φW					
Cold Formed Steel (Gr 55 min.)	12ga (.1050")	3	#10	69	110	69	110	61	98	53	85	45	72	37	59	33	53			
		3	#12	69	110	69	110	61	98	53	85	45	72	37	59	33	53			
		3	1/4"	69	110	69	110	61	98	53	85	45	72	37	59	33	53			
	14ga (.0700")	3	#10	69	110	69	110	61	98	53	85	45	72	37	59	33	53			
		3	#12	69	110	69	110	61	98	53	85	45	72	37	59	33	53			
		3	1/4"	69	110	69	110	61	98	53	85	45	72	37	59	33	53			
	16ga (.0590")	3	#10	69	110	69	110	61	98	53	85	45	72	37	59	33	53			
		3	#12	69	110	69	110	61	98	53	85	45	72	37	59	33	53			
		3	1/4"	69	110	69	110	61	98	53	85	45	72	37	59	33	53			
	18ga (.0470")	3	#10	69	110	69	110	61	98	53	85	45	72	37	59	33	53			
		3	#12	69	110	69	110	61	98	53	85	45	72	37	59	33	53			
		3	1/4"	69	110	69	110	61	98	53	85	45	72	37	59	33	53			
Cold Formed Steel (Gr 33 min.)	16ga (.0598")	3	#10	69	110	69	110	61	94	50	75	42	62	36	53	33	50			
		3	#12	69	110	69	110	61	98	53	85	45	71	37	59	33	53			
		3	1/4"	69	110	69	110	61	98	53	85	45	72	37	59	33	53			
	18ga (.0478")	3	#10	69	110	67	100	50	75	40	60	33	50	29	43	27	40			
		3	#12	69	110	69	110	57	85	45	68	38	57	32	49	30	45			
		3	1/4"	69	110	69	110	61	98	53	79	44	66	37	56	33	53			
	20ga (.0359")	3	#10	69	110	50	75	37	56	30	45	25	37	21	32	20	30			
		3	#12	69	110	57	85	43	64	34	51	28	43	24	36	23	34			
		3	1/4"	69	110	66	99	49	74	39	59	33	49	28	42	26	40			
	22ga (.0299")	3	#10	62	94	42	63	31	47	25	38	21	31	18	27	17	25			
		3	#12	69	107	47	71	35	53	28	43	24	36	20	31	19	29			
		3	1/4"	69	110	55	82	41	62	33	49	27	41	23	35	22	33			
Plywood & OSB	15/32"	3	#10	69	96	47	64	35	48	28	38	24	32	20	27	19	26			
		3	#12	69	109	54	72	40	54	32	43	27	36	23	31	21	29			
		3	#14	69	110	59	80	44	60	36	48	30	40	25	34	24	32			
	19/32"	3	#10	69	110	60	81	45	61	36	49	30	41	26	35	24	32			
		3	#12	69	110	68	92	51	69	41	55	34	46	29	39	27	37			
		3	#14	69	110	69	101	56	76	45	61	37	51	32	43	30	40			
	23/32"	3	#10	69	110	69	98	54	73	43	59	36	49	31	42	29	39			
		3	#12	69	110	69	110	61	84	49	67	41	56	35	48	33	45			
		3	#14	69	110	69	110	61	92	53	73	45	61	37	52	33	49			
Lumber (DFL)	1" min	3	#10	69	110	69	110	61	98	53	85	45	72	37	59	33	53			
		3	#12	69	110	69	110	61	98	53	85	45	72	37	59	33	53			
		3	#14	69	110	69	110	61	98	53	85	45	72	37	59	33	53			

**Specific Notes (Refer to the General Notes section for other applicable notes):**

1. Table accounts for increased loads on fasteners due to the eccentricity of the fasteners relative to the panel seam. The Prestige Series panel summary chart at the front of this section provides for development of these fastener load adjustments.

2. Number of fasteners can be reduced to (2) if project load requirements can still be met. Reduce stated capacities above by 1/2 (the third fastener @ panel nailing flange does not factor into the above capacities).



**Table 5.10 - Section properties (1" reveal Prestige Series):**

Gauge	Weight	Base Metal Thickness	Yield Strength	Tensile Strength	Gross Section Properties				
					Area	Moment of Inertia	Distance to N.A. from Bottom	Positive Section Modulus	Negative Section Modulus
	w	t	Fy	Fu	A <sub>g</sub>	I <sub>g</sub>	y <sub>b</sub>	S <sub>g+</sub>	S <sub>g-</sub>
	psf	in	ksi	ksi	in <sup>2</sup> /ft	in <sup>4</sup> /ft	in	in <sup>3</sup> /ft	in <sup>3</sup> /ft
24	1.51	0.0232	50	65	0.4295	0.1444	1.06	0.3222	0.1363
22	1.89	0.0294	50	65	0.5426	0.1800	1.05	0.4019	0.1703
20	2.27	0.0354	40	55	0.6517	0.2130	1.05	0.4769	0.2028
18	2.93	0.0459	40	55	0.8415	0.2680	1.04	0.6026	0.2582

Gauge	Effective Section Properties							Uniform Load Only	
	Area	Positive			Negative			I <sub>d</sub> = (2I <sub>e</sub> +I <sub>g</sub> )/3	
		Moment of Inertia	Distance to N.A. from Bottom	Section Modulus	Moment of Inertia	Distance to N.A. from Bottom	Section Modulus		
A <sub>e</sub> /ft	I <sub>e+</sub>	y <sub>b</sub>	S <sub>e+</sub>	I <sub>e-</sub>	y <sub>b</sub>	S <sub>e-</sub>	I <sub>+</sub>	I <sub>-</sub>	
in <sup>2</sup>	in <sup>4</sup> /ft	in	in <sup>3</sup> /ft	in <sup>4</sup> /ft	in	in <sup>3</sup> /ft	in <sup>4</sup> /ft	in <sup>4</sup> /ft	
24	0.1531	0.0552	0.58	0.0598	0.0949	1.18	0.0807	0.0849	0.1114
22	0.2130	0.0752	0.61	0.0843	0.1264	1.15	0.1098	0.1101	0.1443
20	0.2863	0.1010	0.65	0.1187	0.1610	1.13	0.1430	0.1383	0.1783
18	0.4039	0.1420	0.68	0.1773	0.2120	1.11	0.1917	0.1840	0.2307

**Table 5.11 - Allowable reactions at supports (1" reveal Prestige Series):**

Gauge	Condition	Allowable (lbs/ft width)	Factored (lbs/ft width)
24	1- End	460	737
	2- Interior	522	835
22	1- End	619	991
	2- Interior	720	1153
20	1- End	619	991
	2- Interior	720	1153
18	1- End	619	991
	2- Interior	720	1153

Reaction capacities based on a minimum 1.5" web bearing length





Table 5.12 - Positive (inward) uniform load design values (1" reveal Prestige Series):

Gauge	Span	Condition	Positive (Inward) Uniform Load Capacity (lbs/ft <sup>2</sup> ) / Span (ft. - in.)						
			2' - 0"	3' - 0"	4' - 0"	5' - 0"	6' - 0"	7' - 0"	7' - 6"
24	Single Span	ASD, W/Ω	298	133	75	48	33	24	21
		LRFD, φW	473	210	118	76	53	39	34
		L/180	-	-	-	-	-	22	18
		L/60	-	-	-	-	-	-	-
	Double Span	ASD, W/Ω	209	139	95	62	43	32	28
		LRFD, φW	334	223	144	93	65	49	42
		L/180	-	-	-	-	-	-	-
	Triple Span	ASD, W/Ω	237	158	117	77	53	40	35
		LRFD, φW	380	253	176	116	81	60	52
L/180		-	-	-	-	-	-	33	
22	Single Span	ASD, W/Ω	421	187	105	67	47	34	30
		LRFD, φW	667	297	167	107	74	54	47
		L/180	-	-	-	-	45	28	23
		L/60	-	-	-	-	-	-	-
	Double Span	ASD, W/Ω	288	192	129	84	59	44	38
		LRFD, φW	461	307	194	126	89	66	57
		L/180	-	-	-	-	-	-	-
	Triple Span	ASD, W/Ω	327	218	157	103	73	53	47
		LRFD, φW	524	349	237	155	109	81	71
L/180		-	-	-	-	-	53	43	
20	Single Span	ASD, W/Ω	474	211	118	76	53	39	34
		LRFD, φW	752	334	188	120	84	61	53
		L/180	-	-	-	-	-	35	29
		L/60	-	-	-	-	-	-	-
	Double Span	ASD, W/Ω	288	192	133	86	61	45	40
		LRFD, φW	461	307	200	130	91	68	60
		L/180	-	-	-	-	-	-	-
	Triple Span	ASD, W/Ω	327	218	161	106	75	56	49
		LRFD, φW	524	349	242	160	113	84	74
L/180		-	-	-	-	-	-	-	
18	Single Span	ASD, W/Ω	619	315	177	113	79	58	50
		LRFD, φW	991	499	281	180	125	92	80
		L/180	-	-	-	-	74	47	38
		L/60	-	-	-	-	-	-	-
	Double Span	ASD, W/Ω	288	192	144	115	81	60	53
		LRFD, φW	461	307	231	174	122	90	80
		L/180	-	-	-	-	-	-	-
	Triple Span	ASD, W/Ω	327	218	164	131	100	75	65
		LRFD, φW	524	349	262	210	151	113	98
L/180		-	-	-	-	-	-	-	
L/60	-	-	-	-	-	-	-	-	

Table values denoted by "-" indicate that capacities are limited by panel strength not deflection.



Clip/fastener attachment schedules (1" reveal Prestige Series panel):

Tables 5.6 to 5.9 apply

**Table 5.13 - Section properties (2" reveal Prestige Series):**

Gauge	Weight	Base Metal Thickness	Yield Strength	Tensile Strength	Gross Section Properties				
					Area	Moment of Inertia	Distance to N.A. from Bottom	Positive Section Modulus	Negative Section Modulus
	w	t	Fy	Fu	A <sub>g</sub>	I <sub>g</sub>	y <sub>b</sub>	S <sub>g+</sub>	S <sub>g-</sub>
	psf	in	ksi	ksi	in <sup>2</sup> /ft	in <sup>4</sup> /ft	in	in <sup>3</sup> /ft	in <sup>3</sup> /ft
24	1.51	0.0232	50	65	0.4295	0.1480	1.00	0.2924	0.1478
22	1.89	0.0294	50	65	0.5426	0.1840	1.00	0.3649	0.1849
20	2.27	0.0354	40	55	0.6517	0.2180	0.99	0.4333	0.2203
18	2.93	0.0459	40	55	0.8415	0.2760	0.98	0.5483	0.2808

Gauge	Effective Section Properties							Uniform Load Only	
	Area	Positive			Negative			I <sub>d</sub> = (2I <sub>e</sub> +I <sub>g</sub> )/3	
		Moment of Inertia	Distance to N.A. from Bottom	Section Modulus	Moment of Inertia	Distance to N.A. from Bottom	Section Modulus		
A <sub>e</sub> /ft	I <sub>e</sub> <sup>+</sup>	y <sub>b</sub>	S <sub>e</sub> <sup>+</sup>	I <sub>e</sub> <sup>-</sup>	y <sub>b</sub>	S <sub>e</sub> <sup>-</sup>	I <sub>+</sub>	I <sub>-</sub>	
in <sup>2</sup>	in <sup>4</sup> /ft	in	in <sup>3</sup> /ft	in <sup>4</sup> /ft	in	in <sup>3</sup> /ft	in <sup>4</sup> /ft	in <sup>4</sup> /ft	
24	0.1547	0.0557	0.57	0.0593	0.0938	1.15	0.0816	0.0865	0.1119
22	0.2163	0.0761	0.59	0.0835	0.1257	1.12	0.1121	0.1121	0.1451
20	0.2935	0.1020	0.62	0.1173	0.1630	1.09	0.1499	0.1407	0.1813
18	0.4235	0.1450	0.66	0.1750	0.2210	1.05	0.2102	0.1887	0.2393

**Table 5.14 - Allowable reactions at supports (2" reveal Prestige Series):**

Gauge	Condition	Allowable (lbs/ft width)	Factored (lbs/ft width)
24	1- End	460	737
	2- Interior	522	835
22	1- End	619	991
	2- Interior	720	1153
20	1- End	619	991
	2- Interior	720	1153
18	1- End	619	991
	2- Interior	720	1153

Reaction capacities based on a minimum 1.5" web bearing length



Table 5.15 - Positive (inward) uniform load design values (2" reveal Prestige Series):

Gauge	Span	Condition	Positive (Inward) Uniform Load Capacity (lbs/ft <sup>2</sup> ) / Span (ft. - in.)						
			2' - 0"	3' - 0"	4' - 0"	5' - 0"	6' - 0"	7' - 0"	7' - 6"
24	Single Span	ASD, W/Ω	296	132	74	47	33	24	21
		LRFD, φW	469	209	117	75	52	38	33
		L/180	-	-	-	-	-	22	18
	Double Span	L/60	-	-	-	-	-	-	-
		ASD, W/Ω	209	139	96	62	43	32	28
		LRFD, φW	334	223	145	94	66	49	42
	Triple Span	L/180	-	-	-	-	-	-	-
		L/60	-	-	-	-	-	-	-
		ASD, W/Ω	237	158	118	77	54	40	34
22	Single Span	LRFD, φW	380	253	178	116	81	60	52
		L/180	-	-	-	-	-	-	34
		L/60	-	-	-	-	-	-	-
	Double Span	ASD, W/Ω	417	185	104	67	46	34	30
		LRFD, φW	661	294	165	106	73	54	47
		L/180	-	-	-	-	45	29	23
	Triple Span	L/60	-	-	-	-	-	-	-
		ASD, W/Ω	288	192	131	86	60	45	38
		LRFD, φW	461	307	197	129	91	67	58
20	Single Span	L/180	-	-	-	-	-	-	-
		L/60	-	-	-	-	-	-	-
		ASD, W/Ω	327	218	160	105	74	55	48
	Double Span	LRFD, φW	524	349	241	159	112	82	72
		L/180	-	-	-	-	-	54	44
		L/60	-	-	-	-	-	-	-
	Triple Span	ASD, W/Ω	468	208	117	75	52	38	33
		LRFD, φW	743	330	186	119	83	61	53
		L/180	-	-	-	-	-	36	29
18	Single Span	L/60	-	-	-	-	-	-	-
		ASD, W/Ω	288	192	138	90	63	47	41
		LRFD, φW	461	307	207	136	96	71	62
	Double Span	L/180	-	-	-	-	-	-	-
		L/60	-	-	-	-	-	-	-
		ASD, W/Ω	327	218	164	111	79	58	51
	Triple Span	LRFD, φW	524	349	252	167	118	88	77
		L/180	-	-	-	-	-	-	-
		L/60	-	-	-	-	-	-	-
18	Single Span	ASD, W/Ω	619	310	175	112	78	57	50
		LRFD, φW	991	493	277	177	123	90	79
		L/180	-	-	-	-	76	48	39
	Double Span	L/60	-	-	-	-	-	-	-
		ASD, W/Ω	288	192	144	115	89	65	57
		LRFD, φW	461	307	231	184	134	99	86
	Triple Span	L/180	-	-	-	-	-	-	-
		L/60	-	-	-	-	-	-	-
		ASD, W/Ω	327	218	164	131	109	81	71
Triple Span	LRFD, φW	524	349	262	210	164	122	107	
	L/180	-	-	-	-	-	-	-	
	L/60	-	-	-	-	-	-	-	

Table values denoted by "-" indicate that capacities are limited by panel strength not deflection.



**Table 5.16 - Clip/fastener attachment schedule (No. 20 and 22 gage Prestige Series with 2" reveal, DIRECT FASTENED):**

Substrate		Fastener		Attachment Spacing, (ft-in)													
		#	Size	2' - 0"	3' - 0"	4' - 0"	5' - 0"	6' - 0"	7' - 0"	7' - 6"							
				Panel Negative (Outward) Uniform Load Capacity, (lbs/ft <sup>2</sup> )													
				27	40	26	40	26	39	26	38	25	38	25	37	25	37
Panel System Negative (Outward) Uniform Load Capacity, (lbs/ft <sup>2</sup> )																	
				ASD	LRFD	ASD	LRFD	ASD	LRFD	ASD	LRFD	ASD	LRFD	ASD	LRFD		
				W/Ω	φW	W/Ω	φW	W/Ω	φW	W/Ω	φW	W/Ω	φW	W/Ω	φW		
Cold Formed Steel (Gr 55 min.)	12ga (.1050")	1	#10	27	40	26	40	26	39	26	38	25	38	25	37	25	37
		1	#12	27	40	26	40	26	39	26	38	25	38	25	37	25	37
		1	1/4"	27	40	26	40	26	39	26	38	25	38	25	37	25	37
	14ga (.0700")	1	#10	27	40	26	40	26	39	26	38	25	38	25	37	25	37
		1	#12	27	40	26	40	26	39	26	38	25	38	25	37	25	37
		1	1/4"	27	40	26	40	26	39	26	38	25	38	25	37	25	37
	16ga (.0590")	1	#10	27	40	26	40	26	39	26	38	25	38	25	37	25	37
		1	#12	27	40	26	40	26	39	26	38	25	38	25	37	25	37
		1	1/4"	27	40	26	40	26	39	26	38	25	38	25	37	25	37
	18ga (.0470")	1	#10	27	40	26	40	26	39	26	38	25	38	25	37	24	35
		1	#12	27	40	26	40	26	39	26	38	25	38	25	37	25	37
		1	1/4"	27	40	26	40	26	39	26	38	25	38	25	37	25	37
Cold Formed Steel (Gr 33 min.)	16ga (.0598")	1	#10	27	40	26	40	26	39	26	38	24	36	21	31	19	29
		1	#12	27	40	26	40	26	39	26	38	25	38	24	35	22	33
		1	1/4"	27	40	26	40	26	39	26	38	25	38	25	37	25	37
	18ga (.0478")	1	#10	27	40	26	40	26	39	23	35	19	29	17	25	15	23
		1	#12	27	40	26	40	26	39	26	38	22	33	19	28	18	26
		1	1/4"	27	40	26	40	26	39	26	38	25	38	22	33	20	31
	20ga (.0359")	1	#10	27	40	26	40	22	33	17	26	14	22	12	19	12	17
		1	#12	27	40	26	40	25	37	20	30	16	25	14	21	13	20
		1	1/4"	27	40	26	40	26	39	23	34	19	29	16	25	15	23
	22ga (.0299")	1	#10	27	40	24	36	18	27	14	22	12	18	10	16	10	15
		1	#12	27	40	26	40	21	31	16	25	14	21	12	18	11	17
		1	1/4"	27	40	26	40	24	36	19	29	16	24	14	20	13	19
Plywood & OSB	15/32"	1	#10	27	40	26	37	21	28	16	22	14	19	12	16	11	15
		1	#12	27	40	26	40	23	32	19	25	16	21	13	18	12	17
		1	#14	27	40	26	40	26	35	21	28	17	23	15	20	14	19
	19/32"	1	#10	27	40	26	40	26	35	21	28	17	24	15	20	14	19
		1	#12	27	40	26	40	26	39	24	32	20	27	17	23	16	21
		1	#14	27	40	26	40	26	39	26	35	22	29	19	25	17	23
	23/32"	1	#10	27	40	26	40	26	39	25	34	21	28	18	24	17	23
		1	#12	27	40	26	40	26	39	26	38	24	32	20	28	19	26
		1	#14	27	40	26	40	26	39	26	38	25	36	23	30	21	28
Lumber (DFL)	1" min	1	#10	27	40	26	40	26	39	26	38	25	38	25	37	25	37
		1	#12	27	40	26	40	26	39	26	38	25	38	25	37	25	37
		1	#14	27	40	26	40	26	39	26	38	25	38	25	37	25	37



**Table 5.17 - Clip/fastener attachment schedule (No. 24 gage Prestige Series with 2" reveal, DIRECT FASTENED):**

Substrate		Fastener		Attachment Spacing, (ft-in)														
				2' - 0"		3' - 0"		4' - 0"		5' - 0"		6' - 0"		7' - 0"		7' - 6"		
		#	Size	Panel Negative (Outward) Uniform Load Capacity, (lbs/ft <sup>2</sup> )														
				16	23	16	23	16	24	16	24	16	24	16	24	16	24	
Panel System Negative (Outward) Uniform Load Capacity, (lbs/ft <sup>2</sup> )																		
				ASD	LRFD	ASD	LRFD	ASD	LRFD	ASD	LRFD	ASD	LRFD	ASD	LRFD			
				W/Ω	φW	W/Ω	φW	W/Ω	φW	W/Ω	φW	W/Ω	φW	W/Ω	φW			
Cold Formed Steel (Gr 55 min.)	12ga (.1050")	1	#10	16	23	16	23	16	24	16	24	16	24	16	24			
		1	#12	16	23	16	23	16	24	16	24	16	24	16	24			
		1	1/4"	16	23	16	23	16	24	16	24	16	24	16	24			
	14ga (.0700")	1	#10	16	23	16	23	16	24	16	24	16	24	16	24			
		1	#12	16	23	16	23	16	24	16	24	16	24	16	24			
		1	1/4"	16	23	16	23	16	24	16	24	16	24	16	24			
	16ga (.0590")	1	#10	16	23	16	23	16	24	16	24	16	24	16	24			
		1	#12	16	23	16	23	16	24	16	24	16	24	16	24			
		1	1/4"	16	23	16	23	16	24	16	24	16	24	16	24			
	18ga (.0470")	1	#10	16	23	16	23	16	24	16	24	16	24	16	24			
		1	#12	16	23	16	23	16	24	16	24	16	24	16	24			
		1	1/4"	16	23	16	23	16	24	16	24	16	24	16	24			
Cold Formed Steel (Gr 33 min.)	16ga (.0598")	1	#10	16	23	16	23	16	24	16	24	16	24	16	24			
		1	#12	16	23	16	23	16	24	16	24	16	24	16	24			
		1	1/4"	16	23	16	23	16	24	16	24	16	24	16	24			
	18ga (.0478")	1	#10	16	23	16	23	16	24	16	24	16	24	15	23			
		1	#12	16	23	16	23	16	24	16	24	16	24	16	24			
		1	1/4"	16	23	16	23	16	24	16	24	16	24	16	24			
	20ga (.0359")	1	#10	16	23	16	23	16	24	16	24	14	22	12	19	12	17	
		1	#12	16	23	16	23	16	24	16	24	16	24	14	21	13	20	
		1	1/4"	16	23	16	23	16	24	16	24	16	24	16	24	15	23	
	22ga (.0299")	1	#10	16	23	16	23	16	24	14	22	12	18	10	16	10	15	
		1	#12	16	23	16	23	16	24	16	24	14	21	12	18	11	17	
		1	1/4"	16	23	16	23	16	24	16	24	16	24	14	20	13	19	
Plywood & OSB	15/32"	1	#10	16	23	16	23	16	24	16	22	14	19	12	16	11	15	
		1	#12	16	23	16	23	16	24	16	24	16	21	13	18	12	17	
		1	#14	16	23	16	23	16	24	16	24	16	23	15	20	14	19	
	19/32"	1	#10	16	23	16	23	16	24	16	24	16	24	15	20	14	19	
		1	#12	16	23	16	23	16	24	16	24	16	24	16	23	16	21	
		1	#14	16	23	16	23	16	24	16	24	16	24	16	24	16	23	
	23/32"	1	#10	16	23	16	23	16	24	16	24	16	24	16	24	16	23	
		1	#12	16	23	16	23	16	24	16	24	16	24	16	24	16	24	
		1	#14	16	23	16	23	16	24	16	24	16	24	16	24	16	24	
	Lumber (DFL)	1" min	1	#10	16	23	16	23	16	24	16	24	16	24	16	24	16	24
			1	#12	16	23	16	23	16	24	16	24	16	24	16	24	16	24
			1	#14	16	23	16	23	16	24	16	24	16	24	16	24	16	24



**Table 5.18 - Clip/fastener attachment schedule (No. 20 and 22 gage Prestige Series with 2" reveal, CLIP ATTACHED):**

Substrate		Fastener		Attachment Spacing, (ft-in)													
		# per clip	Size	2' - 0"		3' - 0"		4' - 0"		5' - 0"		6' - 0"		7' - 0"		7' - 6"	
				Panel / Clip Negative (Outward) Uniform Load Capacity, (lbs/ft <sup>2</sup> )													
				88	141	88	141	77	123	66	105	55	88	44	70	38	61
Panel System Negative (Outward) Uniform Load Capacity, (lbs/ft <sup>2</sup> )																	
				ASD	LRFD	ASD	LRFD	ASD	LRFD	ASD	LRFD	ASD	LRFD	ASD	LRFD	ASD	LRFD
				W/Ω	φW	W/Ω	φW	W/Ω	φW	W/Ω	φW	W/Ω	φW	W/Ω	φW	W/Ω	φW
Cold Formed Steel (Gr 55 min.)	12ga (.1050")	3	#10	88	141	88	141	77	123	66	105	55	88	44	70	38	61
		3	#12	88	141	88	141	77	123	66	105	55	88	44	70	38	61
		3	1/4"	88	141	88	141	77	123	66	105	55	88	44	70	38	61
	14ga (.0700")	3	#10	88	141	88	141	77	123	66	105	55	88	44	70	38	61
		3	#12	88	141	88	141	77	123	66	105	55	88	44	70	38	61
		3	1/4"	88	141	88	141	77	123	66	105	55	88	44	70	38	61
	16ga (.0590")	3	#10	88	141	88	141	77	123	66	105	55	88	44	70	38	61
		3	#12	88	141	88	141	77	123	66	105	55	88	44	70	38	61
		3	1/4"	88	141	88	141	77	123	66	105	55	88	44	70	38	61
	18ga (.0470")	3	#10	88	141	88	141	76	115	61	92	51	76	44	66	38	61
		3	#12	88	141	88	141	77	123	66	104	55	87	44	70	38	61
		3	1/4"	88	141	88	141	77	123	66	105	55	88	44	70	38	61
Cold Formed Steel (Gr 33 min.)	16ga (.0598")	3	#10	88	141	83	125	62	94	50	75	42	62	36	53	33	50
		3	#12	88	141	88	141	71	106	57	85	47	71	41	61	38	57
		3	1/4"	88	141	88	141	77	123	66	99	55	82	44	70	38	61
	18ga (.0478")	3	#10	88	141	67	100	50	75	40	60	33	50	29	43	27	40
		3	#12	88	141	76	113	57	85	45	68	38	57	32	49	30	45
		3	1/4"	88	141	88	132	66	99	53	79	44	66	38	56	35	53
	20ga (.0359")	3	#10	75	112	50	75	37	56	30	45	25	37	21	32	20	30
		3	#12	85	128	57	85	43	64	34	51	28	43	24	36	23	34
		3	1/4"	88	141	66	99	49	74	39	59	33	49	28	42	26	40
	22ga (.0299")	3	#10	62	94	42	63	31	47	25	38	21	31	18	27	17	25
		3	#12	71	107	47	71	35	53	28	43	24	36	20	31	19	29
		3	1/4"	82	123	55	82	41	62	33	49	27	41	23	35	22	33
Plywood & OSB	15/32"	3	#10	71	96	47	64	35	48	28	38	24	32	20	27	19	26
		3	#12	81	109	54	72	40	54	32	43	27	36	23	31	21	29
		3	#14	88	120	59	80	44	60	36	48	30	40	25	34	24	32
	19/32"	3	#10	88	122	60	81	45	61	36	49	30	41	26	35	24	32
		3	#12	88	138	68	92	51	69	41	55	34	46	29	39	27	37
		3	#14	88	141	75	101	56	76	45	61	37	51	32	43	30	40
	23/32"	3	#10	88	141	72	98	54	73	43	59	36	49	31	42	29	39
		3	#12	88	141	82	111	62	84	49	67	41	56	35	48	33	45
		3	#14	88	141	88	122	68	92	54	73	45	61	39	52	36	49
Lumber (DFL)	1" min	3	#10	88	141	88	141	77	121	66	97	55	81	44	69	38	61
		3	#12	88	141	88	141	77	123	66	105	55	88	44	70	38	61
		3	#14	88	141	88	141	77	123	66	105	55	88	44	70	38	61

**Specific Notes (Refer to the General Notes section for other applicable notes):**

1. Table accounts for increased loads on fasteners due to the eccentricity of the fasteners relative to the panel seam. The Prestige Series panel summary chart at the front of this section provides for development of these fastener load adjustments.

2. Number of fasteners can be reduced to (2) if project load requirements can still be met. Reduce stated capacities above by 1/2 (the third fastener @ panel nailing flange does not factor into the above capacities).





**Table 5.19 - Clip/fastener attachment schedule (No. 24 gage Prestige Series with 2" reveal, CLIP ATTACHED):**

Substrate		Fastener		Attachment Spacing, (ft-in)													
		# per clip	Size	2' - 0"	3' - 0"	4' - 0"	5' - 0"	6' - 0"	7' - 0"	7' - 6"							
				Panel / Clip Negative (Outward) Uniform Load Capacity, (lbs/ft <sup>2</sup> )													
				81	130	81	130	72	115	63	101	54	86	45	71	40	64
Panel System Negative (Outward) Uniform Load Capacity, (lbs/ft <sup>2</sup> )																	
				ASD	LRFD	ASD	LRFD	ASD	LRFD	ASD	LRFD	ASD	LRFD	ASD	LRFD	ASD	LRFD
				W/Ω	φW	W/Ω	φW	W/Ω	φW	W/Ω	φW	W/Ω	φW	W/Ω	φW	W/Ω	φW
Cold Formed Steel (Gr 55 min.)	12ga (.1050")	3	#10	81	130	81	130	72	115	63	101	54	86	45	71	40	64
		3	#12	81	130	81	130	72	115	63	101	54	86	45	71	40	64
		3	1/4"	81	130	81	130	72	115	63	101	54	86	45	71	40	64
	14ga (.0700")	3	#10	81	130	81	130	72	115	63	101	54	86	45	71	40	64
		3	#12	81	130	81	130	72	115	63	101	54	86	45	71	40	64
		3	1/4"	81	130	81	130	72	115	63	101	54	86	45	71	40	64
	16ga (.0590")	3	#10	81	130	81	130	72	115	63	101	54	86	45	71	40	64
		3	#12	81	130	81	130	72	115	63	101	54	86	45	71	40	64
		3	1/4"	81	130	81	130	72	115	63	101	54	86	45	71	40	64
	18ga (.0470")	3	#10	81	130	81	130	72	115	61	92	51	76	44	66	40	61
		3	#12	81	130	81	130	72	115	63	101	54	86	45	71	40	64
		3	1/4"	81	130	81	130	72	115	63	101	54	86	45	71	40	64
Cold Formed Steel (Gr 33 min.)	16ga (.0598")	3	#10	81	130	81	125	62	94	50	75	42	62	36	53	33	50
		3	#12	81	130	81	130	71	106	57	85	47	71	41	61	38	57
		3	1/4"	81	130	81	130	72	115	63	99	54	82	45	70	40	64
	18ga (.0478")	3	#10	81	130	67	100	50	75	40	60	33	50	29	43	27	40
		3	#12	81	130	76	113	57	85	45	68	38	57	32	49	30	45
		3	1/4"	81	130	81	130	66	99	53	79	44	66	38	56	35	53
	20ga (.0359")	3	#10	75	112	50	75	37	56	30	45	25	37	21	32	20	30
		3	#12	81	128	57	85	43	64	34	51	28	43	24	36	23	34
		3	1/4"	81	130	66	99	49	74	39	59	33	49	28	42	26	40
	22ga (.0299")	3	#10	62	94	42	63	31	47	25	38	21	31	18	27	17	25
		3	#12	71	107	47	71	35	53	28	43	24	36	20	31	19	29
		3	1/4"	81	123	55	82	41	62	33	49	27	41	23	35	22	33
Plywood & OSB	15/32"	3	#10	71	96	47	64	35	48	28	38	24	32	20	27	19	26
		3	#12	81	109	54	72	40	54	32	43	27	36	23	31	21	29
		3	#14	81	120	59	80	44	60	36	48	30	40	25	34	24	32
	19/32"	3	#10	81	122	60	81	45	61	36	49	30	41	26	35	24	32
		3	#12	81	130	68	92	51	69	41	55	34	46	29	39	27	37
		3	#14	81	130	75	101	56	76	45	61	37	51	32	43	30	40
	23/32"	3	#10	81	130	72	98	54	73	43	59	36	49	31	42	29	39
		3	#12	81	130	81	111	62	84	49	67	41	56	35	48	33	45
		3	#14	81	130	81	122	68	92	54	73	45	61	39	52	36	49
Lumber (DFL)	1" min	3	#10	81	130	81	130	72	115	63	97	54	81	45	69	40	64
		3	#12	81	130	81	130	72	115	63	101	54	86	45	71	40	64
		3	#14	81	130	81	130	72	115	63	101	54	86	45	71	40	64

**Specific Notes (Refer to the General Notes section for other applicable notes):**

1. Table accounts for increased loads on fasteners due to the eccentricity of the fasteners relative to the panel seam. The Prestige Series panel summary chart at the front of this section provides for development of these fastener load adjustments.

2. Number of fasteners can be reduced to (2) if project load requirements can still be met. Reduce stated capacities above by 1/2 (the third fastener @ panel nailing flange does not factor into the above capacities).





**Table 5.20 - Section properties (6" reveal Prestige Series):**

Gauge	Weight	Base Metal Thickness	Yield Strength	Tensile Strength	Gross Section Properties				
					Area	Moment of Inertia	Distance to N.A. from Bottom	Positive Section Modulus	Negative Section Modulus
	w	t	Fy	Fu	A <sub>g</sub>	I <sub>g</sub>	y <sub>b</sub>	S <sub>g+</sub>	S <sub>g-</sub>
	psf	in	ksi	ksi	in <sup>2</sup> /ft	in <sup>4</sup> /ft	in	in <sup>3</sup> /ft	in <sup>3</sup> /ft
24	1.51	0.0232	50	65	0.4295	0.1330	0.77	0.1806	0.1734
22	1.89	0.0294	50	65	0.5426	0.1660	0.76	0.2258	0.2174
20	2.27	0.0354	40	55	0.6517	0.1970	0.76	0.2684	0.2595
18	2.93	0.0459	40	55	0.8415	0.2490	0.75	0.3404	0.3317

Gauge	Effective Section Properties							Uniform Load Only	
	Area	Positive			Negative			I <sub>d</sub> = (2I <sub>e</sub> +I <sub>g</sub> )/3	
		Moment of Inertia	Distance to N.A. from Bottom	Section Modulus	Moment of Inertia	Distance to N.A. from Bottom	Section Modulus		
A <sub>e</sub> /ft	I <sub>e+</sub>	y <sub>b</sub>	S <sub>e+</sub>	I <sub>e-</sub>	y <sub>b</sub>	S <sub>e-</sub>	I <sub>+</sub>	I <sub>-</sub>	
	in <sup>2</sup>	in <sup>4</sup> /ft	in	in <sup>3</sup> /ft	in <sup>4</sup> /ft	in	in <sup>3</sup> /ft	in <sup>4</sup> /ft	in <sup>4</sup> /ft
24	0.1557	0.0567	0.52	0.0577	0.0801	1.02	0.0783	0.0821	0.0977
22	0.2185	0.0778	0.54	0.0808	0.1071	0.99	0.1083	0.1072	0.1267
20	0.2983	0.1051	0.56	0.1127	0.1387	0.95	0.1467	0.1357	0.1581
18	0.4340	0.1500	0.59	0.1666	0.1890	0.90	0.2094	0.1830	0.2090

**Table 5.21 - Allowable reactions at supports (6" reveal Prestige Series):**

Gauge	Condition	Allowable (lbs/ft width)	Factored (lbs/ft width)
24	1- End	460	737
	2- Interior	522	835
22	1- End	619	991
	2- Interior	720	1153
20	1- End	619	991
	2- Interior	720	1153
18	1- End	619	991
	2- Interior	720	1153

Reaction capacities based on a minimum 1.5" web bearing length



Originally Issued: 09/09/2014

Revised: 09/26/2016

Valid Through: 9/30/2017

**Table 5.22 - Positive (inward) uniform load design values (6" reveal Prestige Series):**

Gauge	Span	Condition	Positive (Inward) Uniform Load Capacity (lbs/ft <sup>2</sup> ) / Span (ft - in.)						
			2' - 0"	3' - 0"	4' - 0"	5' - 0"	6' - 0"	7' - 0"	7' - 6"
24	Single Span	ASD, W/Ω	288	128	72	46	32	23	20
		LRFD, φW	456	203	114	73	51	37	32
		L/180	-	-	-	-	-	21	17
		L/60	-	-	-	-	-	-	-
	Double Span	ASD, W/Ω	209	139	93	60	42	31	27
		LRFD, φW	334	223	140	91	63	47	41
		L/180	-	-	-	-	-	-	-
		L/60	-	-	-	-	-	-	-
	Triple Span	ASD, W/Ω	237	158	114	75	52	39	34
LRFD, φW		380	253	172	113	79	59	51	
L/180		-	-	-	-	-	-	32	
L/60		-	-	-	-	-	-	-	
22	Single Span	ASD, W/Ω	403	179	101	65	45	33	29
		LRFD, φW	640	284	160	102	71	52	45
		L/180	-	-	-	-	43	27	22
		L/60	-	-	-	-	-	-	-
	Double Span	ASD, W/Ω	288	192	127	83	58	43	37
		LRFD, φW	461	307	191	125	87	65	56
		L/180	-	-	-	-	-	-	-
		L/60	-	-	-	-	-	-	-
	Triple Span	ASD, W/Ω	327	218	155	102	71	53	46
LRFD, φW		524	349	234	154	108	80	70	
L/180		-	-	-	-	-	52	42	
L/60		-	-	-	-	-	-	-	
20	Single Span	ASD, W/Ω	450	200	112	72	50	37	32
		LRFD, φW	714	317	178	114	79	58	51
		L/180	-	-	-	-	-	35	28
		L/60	-	-	-	-	-	-	-
	Double Span	ASD, W/Ω	288	192	136	88	62	46	41
		LRFD, φW	461	307	204	133	94	70	61
		L/180	-	-	-	-	-	-	-
		L/60	-	-	-	-	-	-	-
	Triple Span	ASD, W/Ω	327	218	164	109	77	57	50
LRFD, φW		524	349	248	164	116	86	75	
L/180		-	-	-	-	-	-	-	
L/60		-	-	-	-	-	-	-	
18	Single Span	ASD, W/Ω	619	296	166	106	74	54	47
		LRFD, φW	991	469	264	169	117	86	75
		L/180	-	-	-	-	-	47	38
		L/60	-	-	-	-	-	-	-
	Double Span	ASD, W/Ω	288	192	144	115	89	66	57
		LRFD, φW	461	307	231	184	133	99	86
		L/180	-	-	-	-	-	-	-
		L/60	-	-	-	-	-	-	-
	Triple Span	ASD, W/Ω	327	218	164	131	109	80	71
LRFD, φW		524	349	262	210	163	121	107	
L/180		-	-	-	-	-	-	-	
L/60		-	-	-	-	-	-	-	

Table values denoted by "-" indicate that capacities are limited by panel strength not deflection.



**Table 5.23 - Clip/fastener attachment schedule (20-22ga Prestige Series with 6" reveal)**

Substrate		Fastener		Attachment Spacing, (ft-in)													
		# per clip	Size	2' - 0"	3' - 0"	4' - 0"	5' - 0"	6' - 0"	7' - 0"	7' - 6"							
				Panel / Clip Negative (Outward) Uniform Load Capacity, (lbs/ft <sup>2</sup> )													
				76	121	76	121	69	110	62	98	54	87	47	75	44	70
Panel System Negative (Outward) Uniform Load Capacity, (lbs/ft <sup>2</sup> )																	
				ASD	LRFD	ASD	LRFD	ASD	LRFD	ASD	LRFD	ASD	LRFD	ASD	LRFD		
				W/Ω	φW	W/Ω	φW	W/Ω	φW	W/Ω	φW	W/Ω	φW	W/Ω	φW		
Cold Formed Steel (Gr 55 min.)	12ga (.1050")	3	#10	76	121	76	121	69	110	62	98	54	87	47	75	44	70
		3	#12	76	121	76	121	69	110	62	98	54	87	47	75	44	70
		3	1/4"	76	121	76	121	69	110	62	98	54	87	47	75	44	70
	14ga (.0700")	3	#10	76	121	76	121	69	110	62	98	54	87	47	75	44	70
		3	#12	76	121	76	121	69	110	62	98	54	87	47	75	44	70
		3	1/4"	76	121	76	121	69	110	62	98	54	87	47	75	44	70
	16ga (.0590")	3	#10	76	121	76	121	69	110	62	98	54	87	47	75	44	70
		3	#12	76	121	76	121	69	110	62	98	54	87	47	75	44	70
		3	1/4"	76	121	76	121	69	110	62	98	54	87	47	75	44	70
	18ga (.0470")	3	#10	76	121	76	121	69	110	61	92	51	76	44	66	41	61
		3	#12	76	121	76	121	69	110	62	98	54	87	47	74	44	69
		3	1/4"	76	121	76	121	69	110	62	98	54	87	47	75	44	70
Cold Formed Steel (Gr 33 min.)	16ga (.0598")	3	#10	76	121	76	121	62	94	50	75	42	62	36	53	33	50
		3	#12	76	121	76	121	69	106	57	85	47	71	41	61	38	57
		3	1/4"	76	121	76	121	69	110	62	98	54	82	47	70	44	66
	18ga (.0478")	3	#10	76	121	67	100	50	75	40	60	33	50	29	43	27	40
		3	#12	76	121	76	113	57	85	45	68	38	57	32	49	30	45
		3	1/4"	76	121	76	121	66	99	53	79	44	66	38	56	35	53
	20ga (.0359")	3	#10	75	112	50	75	37	56	30	45	25	37	21	32	20	30
		3	#12	76	121	57	85	43	64	34	51	28	43	24	36	23	34
		3	1/4"	76	121	66	99	49	74	39	59	33	49	28	42	26	40
	22ga (.0299")	3	#10	62	94	42	63	31	47	25	38	21	31	18	27	17	25
		3	#12	71	107	47	71	35	53	28	43	24	36	20	31	19	29
		3	1/4"	76	121	55	82	41	62	33	49	27	41	23	35	22	33
Plywood & OSB	15/32"	3	#10	71	96	47	64	35	48	28	38	24	32	20	27	19	26
		3	#12	76	109	54	72	40	54	32	43	27	36	23	31	21	29
		3	#14	76	120	59	80	44	60	36	48	30	40	25	34	24	32
	19/32"	3	#10	76	121	60	81	45	61	36	49	30	41	26	35	24	32
		3	#12	76	121	68	92	51	69	41	55	34	46	29	39	27	37
		3	#14	76	121	75	101	56	76	45	61	37	51	32	43	30	40
	23/32"	3	#10	76	121	72	98	54	73	43	59	36	49	31	42	29	39
		3	#12	76	121	76	111	62	84	49	67	41	56	35	48	33	45
		3	#14	76	121	76	121	68	92	54	73	45	61	39	52	36	49
Lumber (DFL)	1" min	3	#10	76	121	76	121	69	110	62	97	54	81	47	69	44	65
		3	#12	76	121	76	121	69	110	62	98	54	87	47	75	44	70
		3	#14	76	121	76	121	69	110	62	98	54	87	47	75	44	70

**Specific Notes (Refer to the General Notes section for other applicable notes):**

1. Table accounts for increased loads on fasteners due to the eccentricity of the fasteners relative to the panel seam. The Prestige Series panel summary chart at the front of this section provides for development of these fastener load adjustments.

2. Number of fasteners can be reduced to (2) if project load requirements can still be met. Reduce stated capacities above by 1/2 (the third fastener @ panel nailing flange does not factor into the above capacities).



**6.0 - Skyline Roofing® & Skyline Roofing® hp**

**Figure 6.1 - Profile: As installed view shown.**

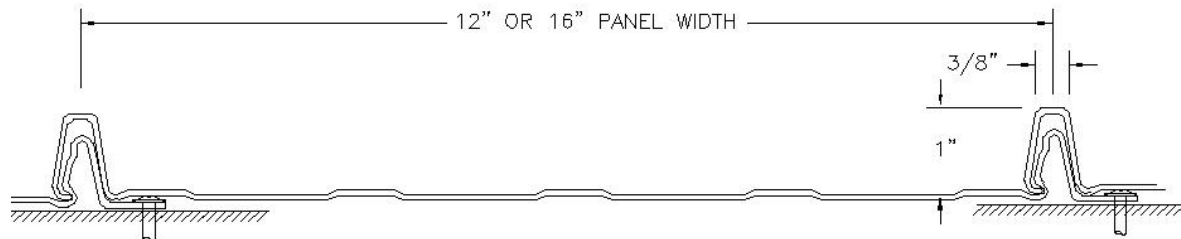

**Table 6.1 – Profile:**

<b>Panel Use:</b>	Roof (primary use), wall, fascia
<b>Substrates:</b>	Over solid or closely fitted deck.
<b>Available Gauges:</b>	No. 24 gage (Skyline Roofing® hp), No. 26 gage (Skyline Roofing®)
<b>Minimum Slope:</b>	3:12 (25 percent)
<b>Load Combination Reduction Available (Ref. Section 5.6)</b>	No.
<b>Uninstalled Panel View</b>	

**Table 6.2 - Attachment:**

<b>Clip Name:</b>	N/A (fastener attached panel)
<b>Clip View:</b>	N/A
<b>Clip Usage:</b>	N/A
<b>Part #:</b>	N/A
<b>Panel/ Substrate Gap:</b>	0 inch
<b>Thermal Movement:</b>	5/16 inch each direction (with centered fastener)
<b>Fastener Limitations:</b>	Nom. size: #10 max. Head height: 0.090 inch max. Head dia.: ½ inch max.
<b>Recommended Fastener(s):</b>	#8 modified truss head, #10 pancake
<b>Fastener Load Adjustment:</b>	N/A
<b>Associated Bearing Plate:</b>	N/A



**Table 6.3 - Section properties (12" Skyline Roofing®):**

Gauge	Weight	Base Metal Thickness	Yield Strength	Tensile Strength	Gross Section Properties				
					Area	Moment of Inertia	Distance to N.A. from Bottom	Positive Section Modulus	Negative Section Modulus
	w	t	Fy	Fu	A <sub>g</sub>	I <sub>g</sub>	y <sub>b</sub>	S <sub>g+</sub>	S <sub>g-</sub>
	psf	in	ksi	ksi	in <sup>2</sup> /ft	in <sup>4</sup> /ft	in	in <sup>3</sup> /ft	in <sup>3</sup> /ft
26	1.01	0.0173	33	45	0.2775	0.0119	0.11	0.0169	0.1082

Gauge	Effective Section Properties							Uniform Load Only	
	Area	Positive			Negative			I <sub>d</sub> = (2I <sub>e</sub> +I <sub>g</sub> )/3	
		Moment of Inertia	Distance to N.A. from Bottom	Section Modulus	Moment of Inertia	Distance to N.A. from Bottom	Section Modulus		
	A <sub>e</sub> /ft in <sup>2</sup>	I <sub>e+</sub> in <sup>4</sup> /ft	y <sub>b</sub> in	S <sub>e+</sub> in <sup>3</sup> /ft	I <sub>e-</sub> in <sup>4</sup> /ft	y <sub>b</sub> in	S <sub>e-</sub> in <sup>3</sup> /ft	I <sub>+</sub> in <sup>4</sup> /ft	I <sub>-</sub> in <sup>4</sup> /ft
26	0.0735	0.0119	0.11	0.0169	0.0069	0.30	0.0136	0.0119	0.0086

**Table 6.4 - Fastener attachment schedule (12", No. 26 gage Skyline Roofing®):**

Substrate	Fastener			Attachment Spacing, (ft-in)									
	#	Size		5.5"		11"		16.5"		22"		27.5"	
				Panel Negative (Outward) Uniform Load Capacity, (lbs/ft <sup>2</sup> )									
				40	60	39	59	37	56	34	53	31	49
Panel System Negative (Outward) Uniform Load Capacity, (lbs/ft <sup>2</sup> )													
		ASD	LRFD	ASD	LRFD	ASD	LRFD	ASD	LRFD	ASD	LRFD	ASD	LRFD
		W/Ω	φW	W/Ω	φW	W/Ω	φW	W/Ω	φW	W/Ω	φW	W/Ω	φW
Plywood & OSB	15/32"	1	#8	40	60	39	59	37	56	34	52	31	42
		1	#10	40	60	39	59	37	56	34	53	31	48
	19/32"	1	#8	40	60	39	59	37	56	34	52	31	42
		1	#10	40	60	39	59	37	56	34	53	31	48
23/32"	1	#8	40	60	39	59	37	56	34	52	31	42	
	1	#10	40	60	39	59	37	56	34	53	31	48	
Lumber (DFL)	1" min	1	#8	40	60	39	59	37	56	34	53	31	49
		1	#10	40	60	39	59	37	56	34	53	31	49



**Table 6.5 - Section properties (16" Skyline Roofing® & Skyline Roofing® hp):**

Gauge	Weight	Base Metal Thickness	Yield Strength	Tensile Strength	Gross Section Properties				
					Area	Moment of Inertia	Distance to N.A. from Bottom	Positive Section Modulus	Negative Section Modulus
	w	t	F <sub>y</sub>	F <sub>u</sub>	A <sub>g</sub>	I <sub>g</sub>	y <sub>b</sub>	S <sub>g+</sub>	S <sub>g-</sub>
	psf	in	ksi	ksi	in <sup>2</sup> /ft	in <sup>4</sup> /ft	in	in <sup>3</sup> /ft	in <sup>3</sup> /ft
26	0.94	0.0173	33	45	0.2659	0.0143	0.11	0.0152	0.1229
24	1.25	0.0232	50	65	0.3551	0.0180	0.12	0.0197	0.1457

Gauge	Effective Section Properties							Uniform Load Only	
	Area	Positive			Negative			I <sub>d</sub> = (2I <sub>e</sub> +I <sub>g</sub> )/3	
		Moment of Inertia	Distance to N.A. from Bottom	Section Modulus	Moment of Inertia	Distance to N.A. from Bottom	Section Modulus		
A <sub>e</sub> /ft in <sup>2</sup>	I <sub>e+</sub> in <sup>4</sup> /ft	y <sub>b</sub> in	S <sub>e+</sub> in <sup>3</sup> /ft	I <sub>e-</sub> in <sup>4</sup> /ft	y <sub>b</sub> in	S <sub>e-</sub> in <sup>3</sup> /ft	I <sub>+</sub> in <sup>4</sup> /ft	I <sub>-</sub> in <sup>4</sup> /ft	
26	0.0568	0.0140	0.11	0.0152	0.0080	0.35	0.0119	0.0141	0.0101
24	0.0774	0.0181	0.12	0.0197	0.0107	0.35	0.0155	0.0181	0.0132

**Table 6.6 - Fastener attachment schedule (16", 24ga Skyline Roofing® hp):**

Substrate		Fastener		Attachment Spacing, (ft-in)									
				5.5"		11"		16.5"		22"		27.5"	
		#	Size	Panel Negative (Outward) Uniform Load Capacity, (lbs/ft <sup>2</sup> )									
				46	74	45	73	44	71	43	69	42	67
		Panel System Negative (Outward) Uniform Load Capacity, (lbs/ft <sup>2</sup> )											
		ASD	LRFD	ASD	LRFD	ASD	LRFD	ASD	LRFD	ASD	LRFD		
		W/Ω	φW	W/Ω	φW	W/Ω	φW	W/Ω	φW	W/Ω	φW		
Plywood & OSB	15/32"	1	#8	46	74	45	73	39	52	29	39	23	31
		1	#10	46	74	45	73	44	61	34	45	27	36
	19/32"	1	#8	46	74	45	73	39	52	29	39	23	31
		1	#10	46	74	45	73	44	61	34	45	27	36
	23/32"	1	#8	46	74	45	73	39	52	29	39	23	31
		1	#10	46	74	45	73	44	61	34	45	27	36
Lumber (DFL)	1" min	1	#8	46	74	45	73	44	71	43	69	42	67
		1	#10	46	74	45	73	44	71	43	69	42	67



**Table 6.7 - Fastener attachment schedule (16", 26ga Skyline Roofing®):**

Substrate		Fastener		Attachment Spacing, (ft-in)											
				5.5"		11"		16.5"		22"		27.5"		33"	
		#	Size	Panel Negative (Outward) Uniform Load Capacity, (lbs/ft <sup>2</sup> )											
				31	50	31	49	30	48	29	46	28	45	26	42
Panel System Negative (Outward) Uniform Load Capacity, (lbs/ft <sup>2</sup> )															
				ASD	LRFD	ASD	LRFD	ASD	LRFD	ASD	LRFD	ASD	LRFD	ASD	LRFD
				W/Ω	φW	W/Ω	φW	W/Ω	φW	W/Ω	φW	W/Ω	φW	W/Ω	φW
Plywood & OSB	15/32"	1	#8	31	50	31	49	30	48	29	39	23	31	19	26
		1	#10	31	50	31	49	30	48	29	45	27	36	22	30
	19/32"	1	#8	31	50	31	49	30	48	29	39	23	31	19	26
		1	#10	31	50	31	49	30	48	29	45	27	36	22	30
	23/32"	1	#8	31	50	31	49	30	48	29	39	23	31	19	26
		1	#10	31	50	31	49	30	48	29	45	27	36	22	30
Lumber (DFL)	1" min	1	#8	31	50	31	49	30	48	29	46	28	45	26	42
		1	#10	31	50	31	49	30	48	29	46	28	45	26	42